

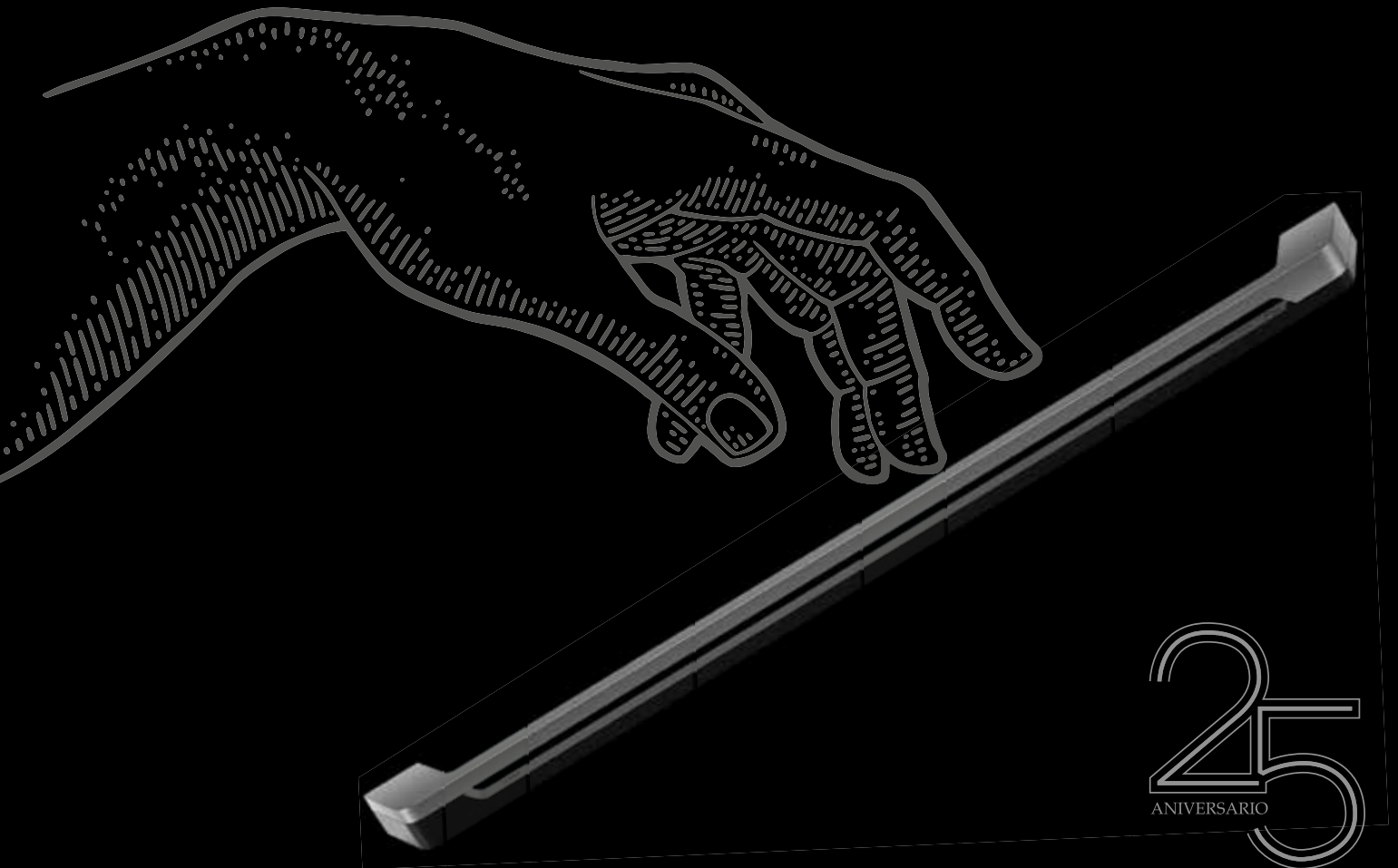

sc herrajes®

*because first
impressions last*



25
ANIVERSARIO



sc herrajes®





sc herrajes®

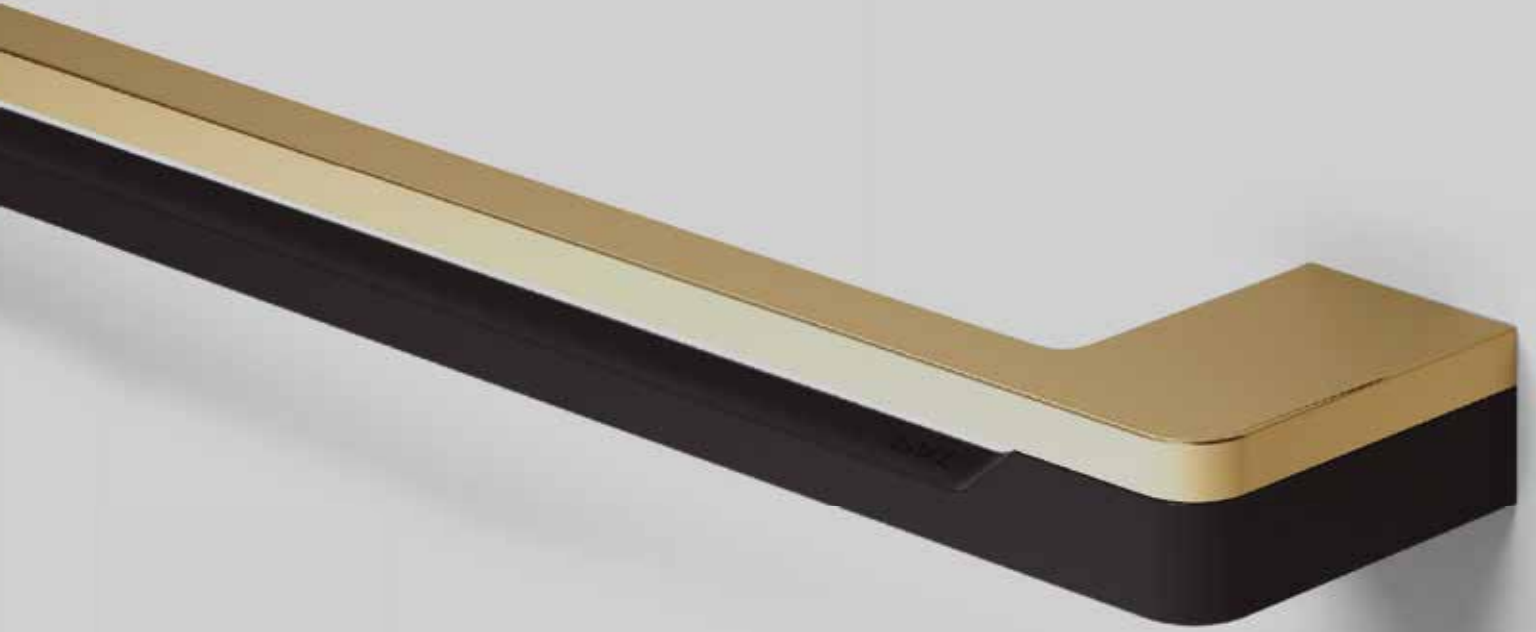

Donde empieza la creación

La primera impresión es la que cuenta,
el tirador como carta de presentación,
una invitación a descubrir.

*The creation begins first
impressions last, the handle is the
calling card, an invitation to discover.*







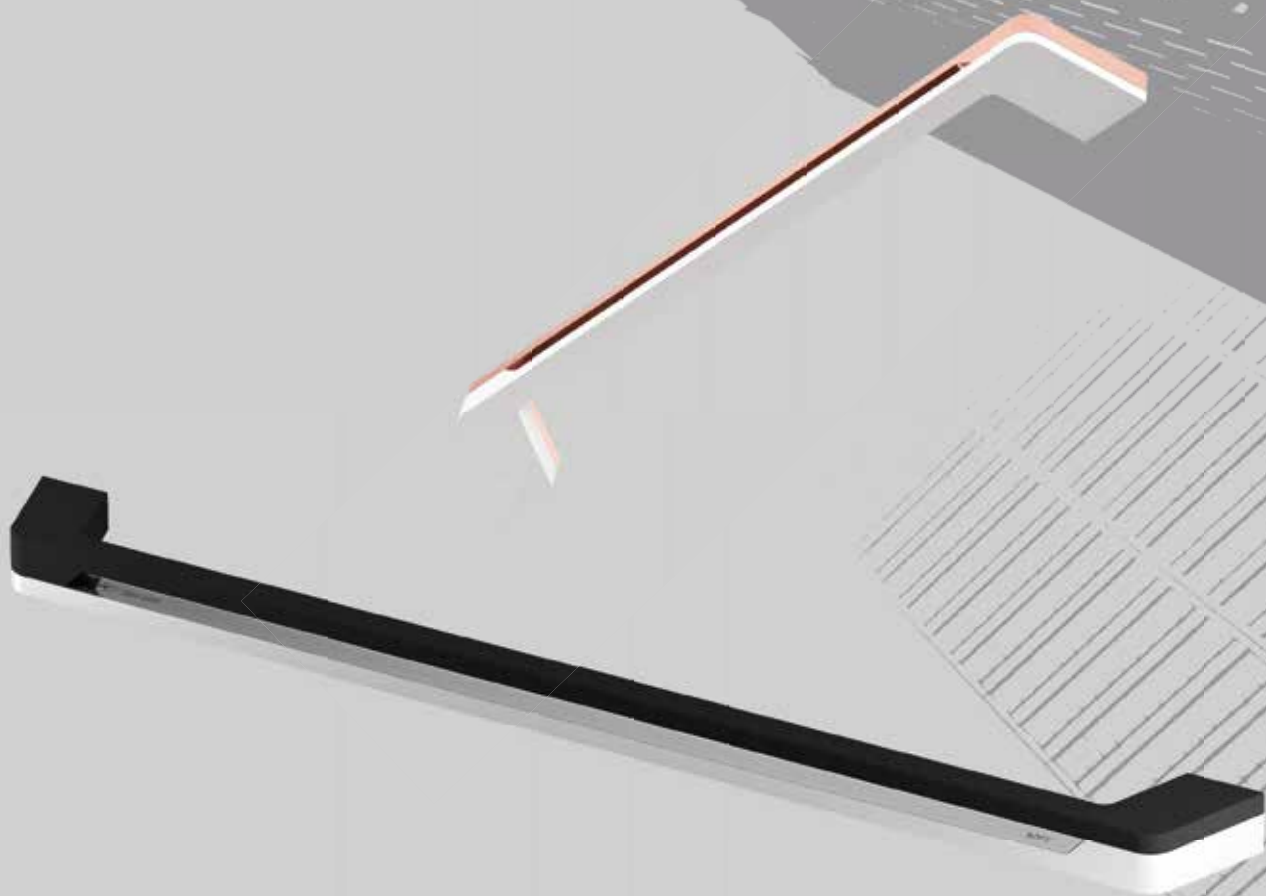

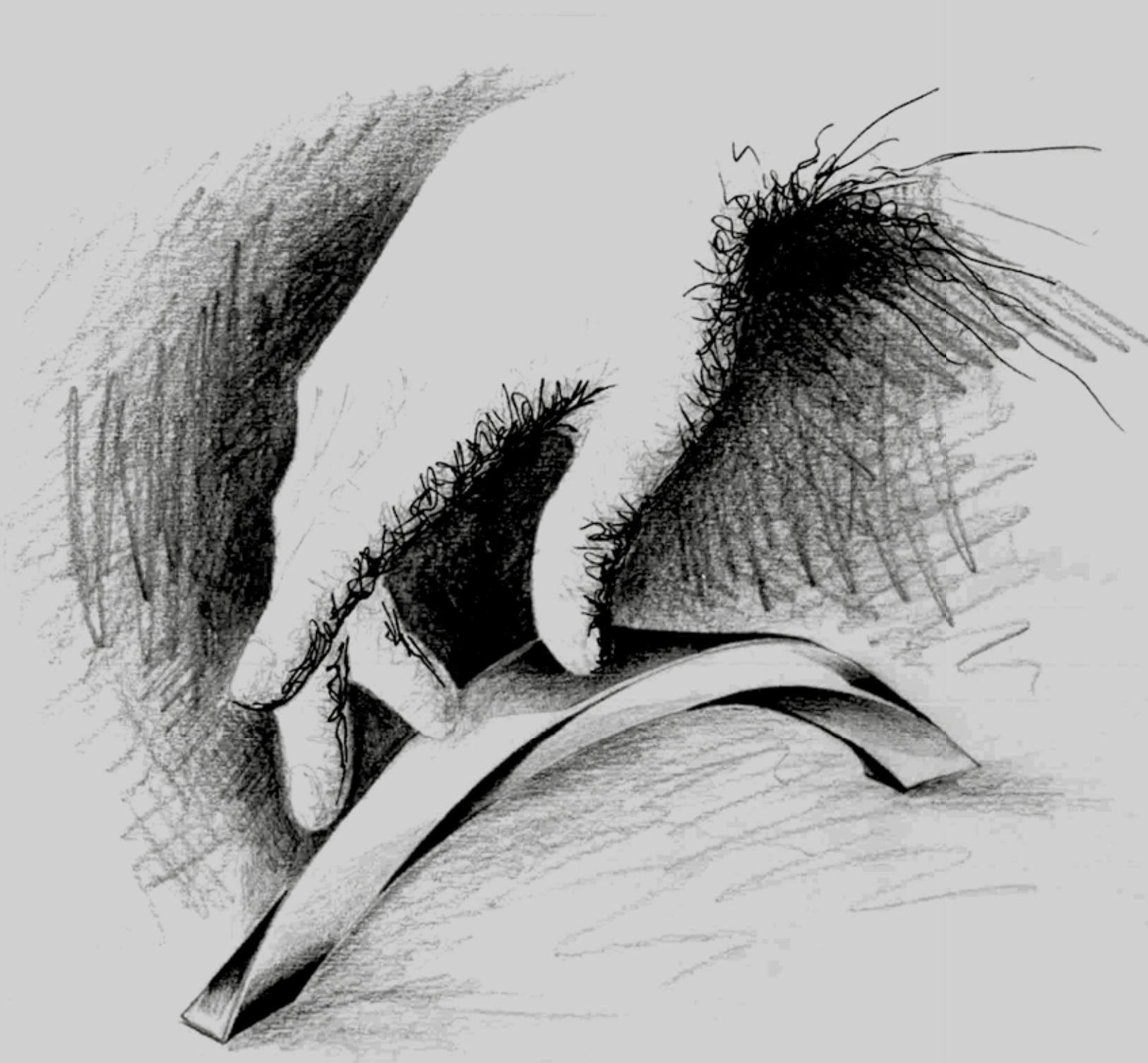
SC nace hace 25 años en 1995 especializándose en el diseño de complementos para la industria del mueble y el conocimiento de su mercado. Nuestro objetivo es conseguir que cada pieza otorgue un valor especial a los entornos más cotidianos, que se mezcle con el espacio para crear un significado personal en cada hogar.

SC was born 25 years ago, in 1995, it specialized in the design of accessories for the furniture industry and also in the knowledge of its market. Our aim is to achieve that every single element provides a special value to the daily environments, which joins up with the space to create a special atmosphere in every home.





sc herrajes®

	01	Perfiles 7 - 21		05	Fusión 87 - 93
	02	Gola 23 - 29		06	Classic 95 - 105
	03	Unique 31 - 36		07	Diverse 107 - 115
	04	Essentials 41 - 85			

Símbolos y señales Key symbols	116
Índice Perfiles Aluminio Index Alu profile	117
Índice Perfiles Gola Index Gola profile	118
Índice Tiradores Index Handles	119 - 122
Índice Diverse Index Diverse	123
Preguntas frecuentes Frequently asked questions	124 - 125
SC Herrajes around the world	126 - 127
Notas Notes	128



sc herrajes®

Perfiles

01

01. Perfiles



848 Puerta 19

Montaje con tornillos

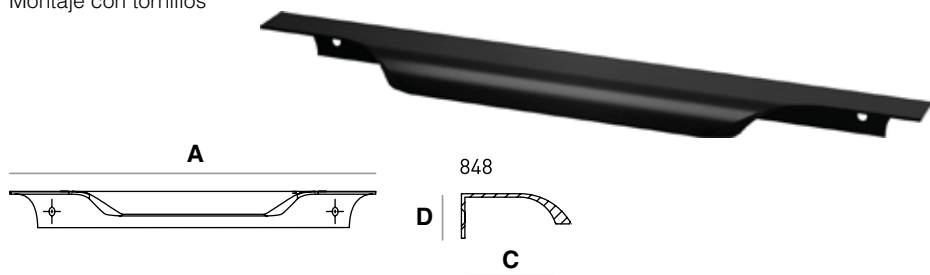

848N Puerta 19

Mecanizado

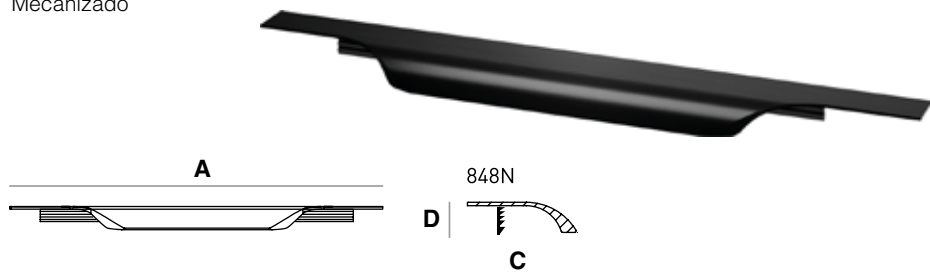

Ref.	A
848. 150	147
848. 200	197
848. 250	247
848. 300	297
848. 350	347
848. 400	397
848. 450	447
848. 500	497
848. 600	597
848. 700	697
848. 800	797
848. 900	897
848.1000	997
848.1200	1197

Acabados Finishes

09	61
	
Anodizado Negro Satinado Anodized Brushed Black	Grafito Satinado Brushed Graphite

C	D	
39	12	20



849 ALUMINIO

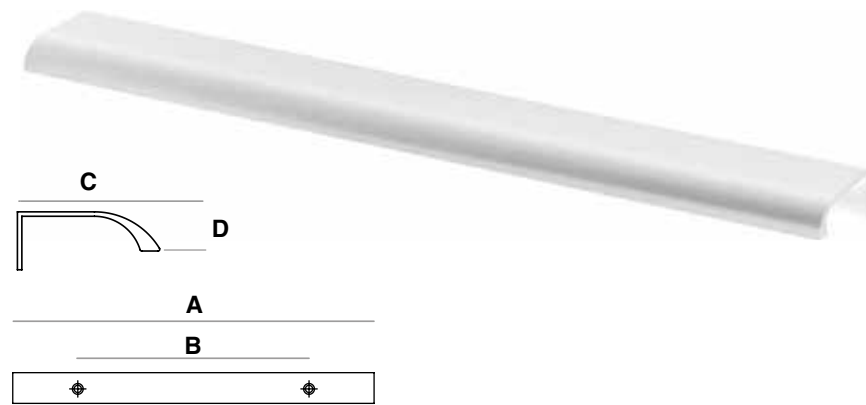

Ref	A	B	C	D		
849.050	50	32	42	11,5	-	20
849.200	200	128				
849.400	400	320				
849.600	600	576				



Acabados Finishes

06	16	31	57	61	98
Lacado blanco White	Dorado Brushed gold	Anonizado plata Anodized silver	Efecto inox Inox effect	Grafito satinado graphite anodized	Cobre Brushed copper

01. Perfiles



771 ALUMINIO Puerta 19

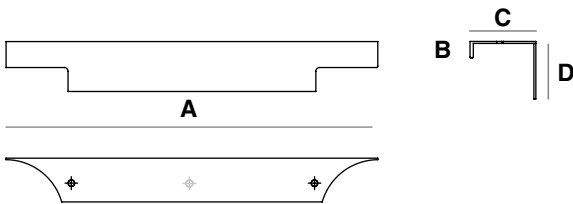

Ref.	A	B
771.150	147	-
771.200	197	-
771.250	247	-
771.300	297	-
771.350	347	-
771.400	397	-
771.450	447	-
771.500	497	-
771.600	597	-
771.700	697	-
771.800	797	-
771.900	897	-
771.1000	997	-
771.1200	1197	-

Acabados Finishes

09	31	57
		
Anonizado negro satinado Anodized Brushed Black	Anonizado plata Anodized silver	Efecto inox Inox effect

C	D		
45	7,5	20	60





772 ALUMINIO Puerta 19

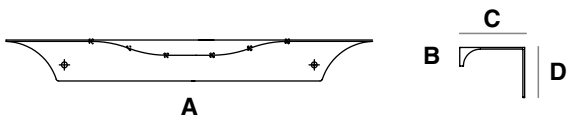

Ref.	A	B
772. 150	147	-
772. 200	197	-
772. 250	247	-
772. 300	297	-
772. 350	347	-
772. 400	397	-
772. 450	447	-
772. 500	497	-
772. 600	597	-
772. 700	697	-
772. 800	797	-
772. 900	897	-
772.1000	997	-
772.1200	1197	-



Acabados Finishes

09	57	61
		
Anodizado negro satinado Anodized Brushed Black	Efecto inox Inox effect	Grafito satinado graphite anodized

C	D		
40	13	25	50

01. Perfiles



769 ALUMINIO Puerta 19

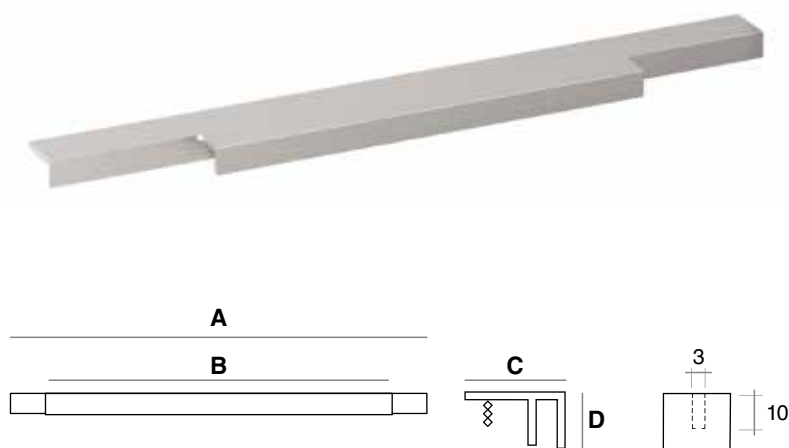

Ref.	A	B
769. 150	148	90
769. 200	198	140
769. 250	248	190
769. 300	298	240
769. 350	348	290
769. 400	398	340
769. 450	448	390
769. 500	498	440
769. 600	598	540
769. 700	698	640
769. 800	798	740
769. 900	898	840
769.1000	998	940
769.1200	1198	1140

Acabados Finishes

57



Efecto inox
Inox effect

C	D		
39	11	20	80



770 ALUMINIO Puerta 19

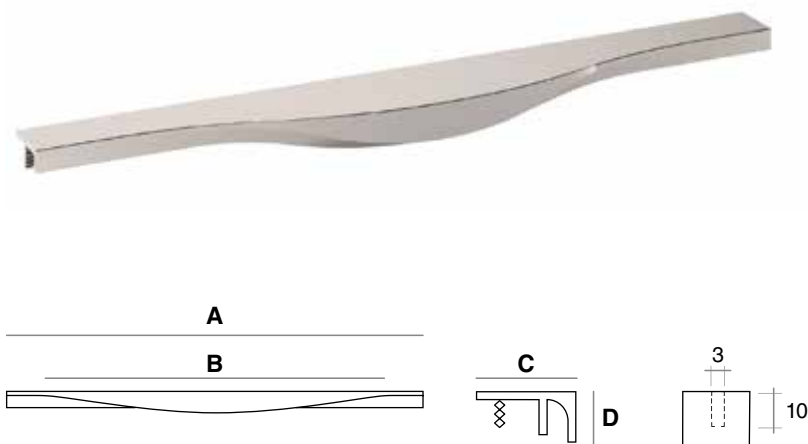

Ref.	A	B
770. 150	148	90
770. 200	198	140
770. 250	248	190
770. 300	298	240
770. 350	348	290
770. 400	398	340
770. 450	448	390
770. 500	498	440
770. 600	598	540
770. 700	698	640
770. 800	798	740
770. 900	898	840
770.1000	998	940
770.1200	1198	1140

Acabados Finishes

57

●
Efecto inox
Inox effect

C	D		
39	11	20	80

01. Perfiles



773 ALUMINIO Puerta 21

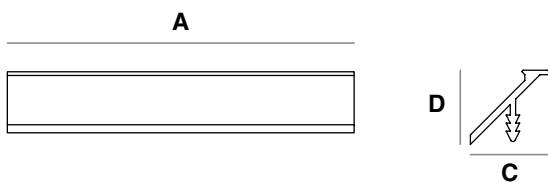

Ref.	A	B
773. 150	147	-
773. 200	197	-
773. 250	247	-
773. 300	297	-
773. 350	347	-
773. 400	397	-
773. 450	447	-
773. 500	497	-
773. 600	597	-
773. 700	697	-
773. 800	797	-
773. 900	897	-
773.1000	997	-
773.1200	1197	-
*Sólo disponibles en acabado 31		
773.3000	3000	-

Acabados Finishes

08	31	57
Lacado negro Black	Anonizado plata Anodized silver	Efecto inox Inox effect

C	D		
17	-	20	-



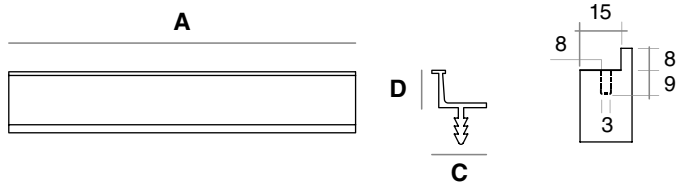

774 ALUMINIO Puerta a partir de 18



Acabados Finishes

08	31	57
 Lacado negro Black	 Anonizado plata Anodized silver	 Efecto inox Inox effect

Ref.	A	B
774. 150	147	-
774. 200	197	-
774. 250	247	-
774. 300	297	-
774. 350	347	-
774. 400	397	-
774. 450	447	-
774. 500	497	-
774. 600	597	-
774. 700	697	-
774. 800	797	-
774. 900	897	-
774.1000	997	-
774.1200	1197	-
*Sólo disponibles en acabados 31 y 57		
773.3000	3000	-

	C	D		
Lacado negro Black Efecto inox Inox effect	15	9	-	12
Anonizado plata Anodized silver	15	9	20	-

01. Perfiles



765 ALUMINIO Puerta 21

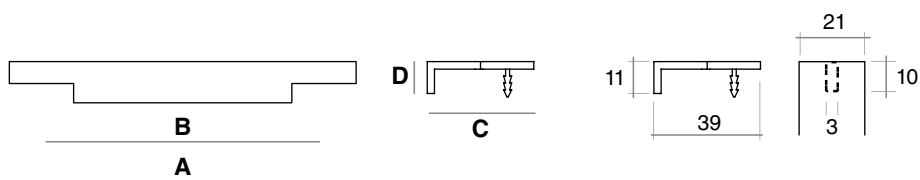

Ref.	A	B
765. 150	148	98
765. 200	198	148
765. 250	248	198
765. 300	298	248
765. 350	348	298
765. 400	398	348
765. 450	448	398
765. 500	498	448
765. 600	598	548
765. 700	698	648
765. 800	798	748
765. 900	898	848
765.1000	998	948
765.1200	1198	1148

Acabados Finishes

07



Anonizado negro
Anodized Black

57



Efecto inox
Inox effect

C	D		
39	11	20	60



768 ALUMINIO Puerta 19

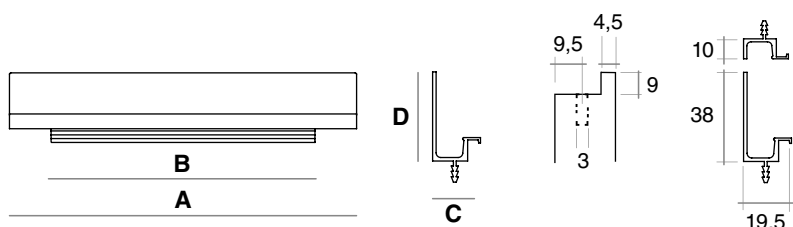
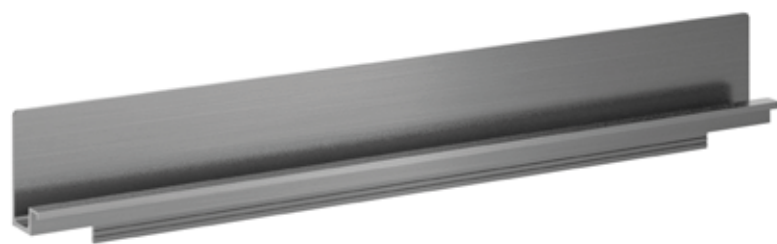

Ref.	A	B
768.19. 150	147	70
768.19. 200	197	120
768.19. 250	247	170
768.19. 300	297	220
768.19. 350	347	270
768.19. 400	397	320
768.19. 450	447	370
768.19. 500	497	420
768.19. 600	597	520
768.19. 700	697	620
768.19. 800	797	720
768.19. 900	897	820
768.19. 1000	997	920
768.19. 1200	1197	1120
768.19. 3000	3000	-

Acabados Finishes

06	09	31	57	61
Lacado blanco White	Anonizado negro satinado Anodized Brushed Black	Anonizado plata Anodized silver	Efecto inox Inox effect	Grafito satinado graphite anodized

C	D		
19,5	38	25	50

01. Perfiles



768 ALUMINIO Puerta 21

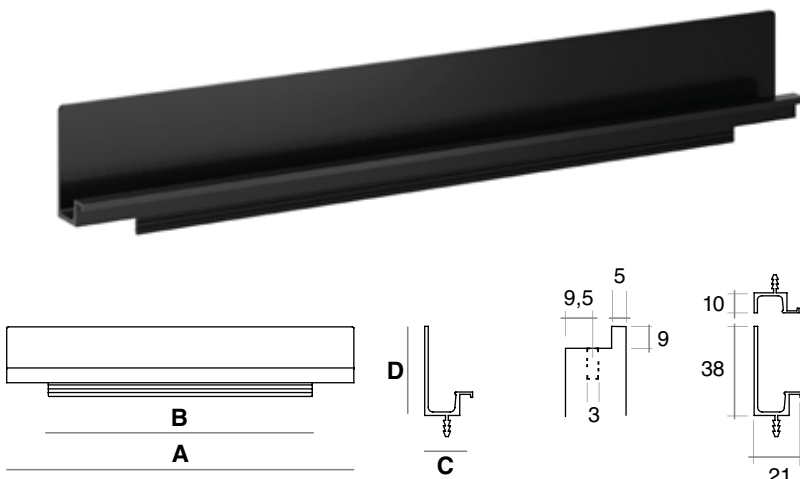

Ref.	A	B
768.21. 150	147	70
768.21. 200	197	120
768.21. 250	247	170
768.21. 300	297	220
768.21. 350	347	270
768.21. 400	397	320
768.21. 450	447	370
768.21. 500	497	420
768.21. 600	597	520
768.21. 700	697	620
768.21. 800	797	720
768.21. 900	897	820
768.21. 1000	997	920
768.21. 1200	1197	1120
768.21. 3000	3000	-

Acabados Finishes

06	09	31	57	61
Lacado blanco White	Anonizado negro satinado Anodized Brushed Black	Anonizado plata Anodized silver	Efecto inox Inox effect	Grafito satinado graphite anodized

C	D		
21	38	25	50



768.19UP ALUMINIO Puerta 19

768.21UP ALUMINIO Puerta 21

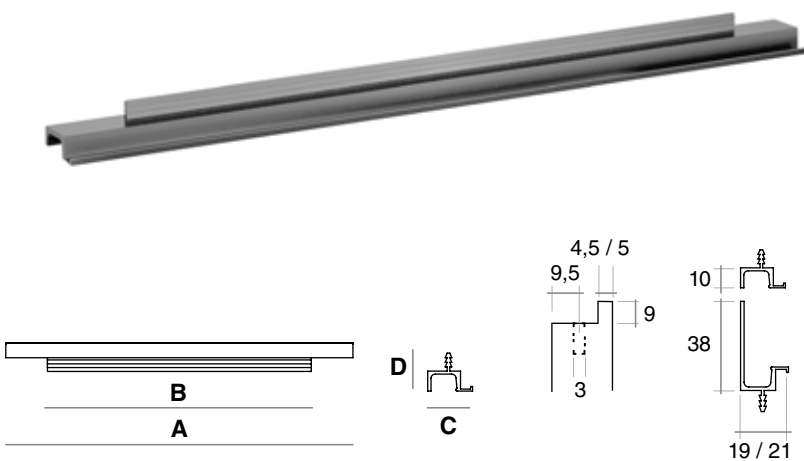

Ref.	A	B
768UP.xx. 150	147	70
768UP.xx. 200	197	120
768UP.xx. 250	247	170
768UP.xx. 300	297	220
768UP.xx. 350	347	270
768UP.xx. 400	397	320
768UP.xx. 450	447	370
768UP.xx. 500	497	420
768UP.xx. 600	597	520
768UP.xx. 700	697	620
768UP.xx. 800	797	720
768UP.xx. 900	897	820
768UP.xx. 1000	997	920
768UP.xx. 1200	1197	1120
*Sólo disponible en acabados 09 - 61		
768UP.xx. 3000	3000	-

Acabados Finishes

06	09	31	57	61
Lacado blanco White	Anonizado negro satinado Anodized Brushed Black	Anonizado plata Anodized silver	Efecto inox Inox effect	Grafito satinado graphite anodized

C	D		
19,5	10	-	20
21	10	-	20

01. Perfiles

761 ALUMINIO Puerta 19

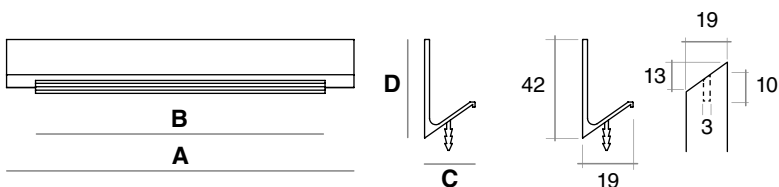

Acabados Finishes

31



Anodizado plata
Anodized silver

Ref.	A	B
761. 150	147	90
761. 200	197	140
761. 250	247	190
761. 300	297	240
761. 350	347	290
761. 400	397	340
761. 450	447	390
761. 500	497	440
761. 600	597	540
761. 700	697	640
761. 800	797	740
761. 900	897	840
761.1000	997	940
761.1200	1197	1140
761.2000	2000	-

C

D



19

42

20

60

762 ALUMINIO Puerta 19

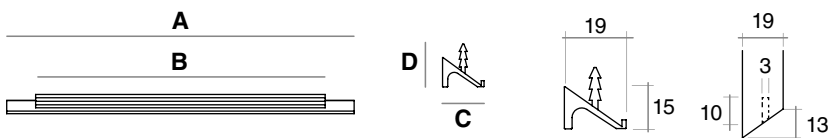

Acabados Finishes

31



Anodizado plata
Anodized silver

Ref.	A	B
762. 150	147	90
762. 200	197	140
762. 250	247	190
762. 300	297	240
762. 350	347	290
762. 400	397	340
762. 450	447	390
762. 500	497	440
762. 600	597	540
762. 700	697	640
762. 800	797	740
762. 900	897	840
762.1000	997	940
762.1200	1197	1140
762.2000	2000	-

C

D



19

15

20

60





sc herrajes®

Gola

02

02. Gola







757 BI-LED

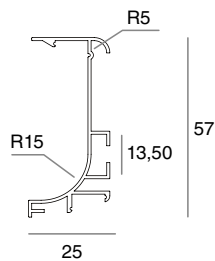

Ref.	A	B
757.4000	4000	-



Acabados Finishes

06	08	31	63
			
Lacado blanco White	Lacado negro Black	Anonizado plata Anodized silver	Lacado gris Grey





757 ACCESORIOS

757 KIT ILUMINACIÓN CAJÓN



Ref.	Descripción		
757. t	Tapa izq+der	-	6
757. r	Rincón	-	6
757. e	Esquina	-	6
758.29	Escuadra sujección metal	-	25
757.29	Escuadra sujección plástico	-	25

kit incluye:
Sensor, cable,
cubierta y led



Ref.	Descripción
757. 10	Kit iluminación 1 metro
757. 20	Kit iluminación 2 metros
757. c	Cubierta PC opaco 2 metros

Acabados Finishes

06	08	31	63
Lacado blanco White	Lacado negro Black	Anonizado plata Anodized silver	Lacado gris Grey

757 SUJECCIONES



25	-
----	---

02. Gola

750

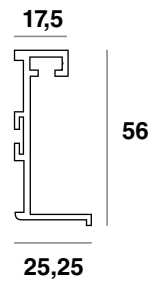
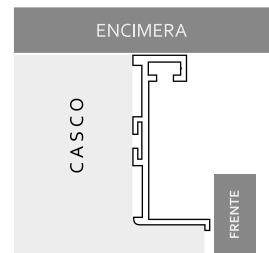

ACCESORIOS

Ref.	Medida	
750.4000	4 metros	6



750.i
Lateral izquierdo



750.d
Lateral derecho



750.r
Rincón 90°



750.e
Esquina 90°

751

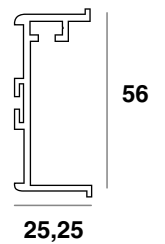
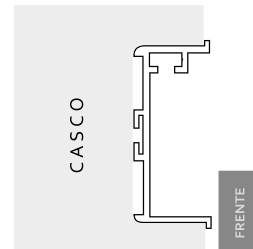

ACCESORIOS

Ref.	Medida	
751.4000	4 metros	6



751.i
Lateral izquierdo



751.d
Lateral derecho

Acabados Finishes

06



Lacado blanco
White

31



Anodizado plata
Anodized silver

753

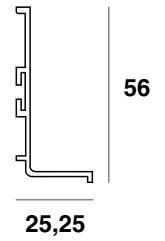
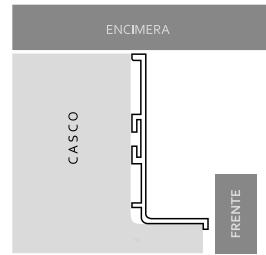

ACCESORIOS

Ref. Medida

753.4000 4 metros 10



753.i
Tapa izquierda



753.d
Tapa derecha

754

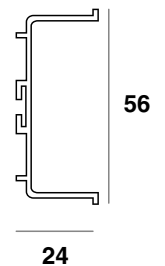
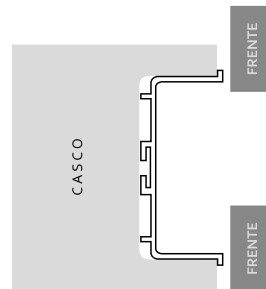

ACCESORIOS

Ref. Medida

754.4000 4 metros 10



754.i
Tapa izquierda



754.d
Tapa derecha

Acabados Finishes

06

Lacado blanco
White

31

Anonizado plata
Anodized silver

02. Gola



752.16

752.19



* Incluye cubierta PVC.

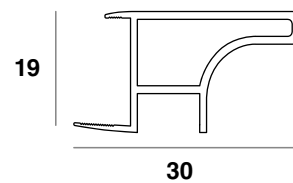
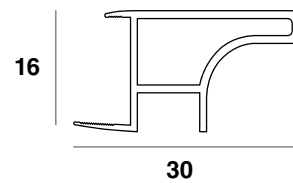

Acabados Finishes

06	08	31	63
Lacado blanco White	Lacado negro Black	Anodizado plata Anodized silver	Lacado gris Grey

Ref.

Descripción

Ref.	Descripción	
752.16	Perfil R 4 metros 16 mm.	20
752.19	Perfil R 4 metros 19 mm.	20
L200R.2000C	Cubierta PVC	-





755

756

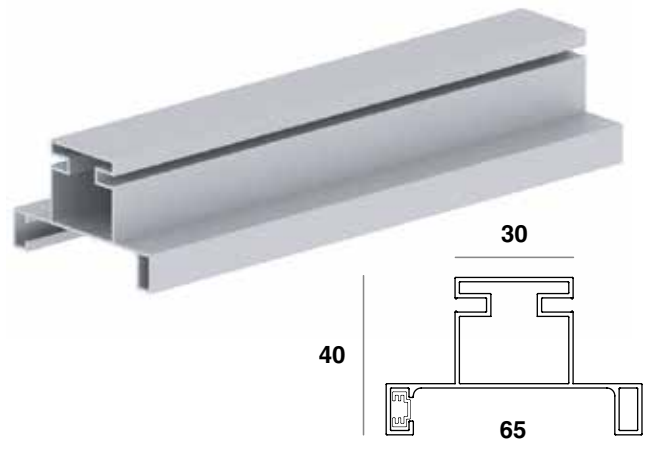
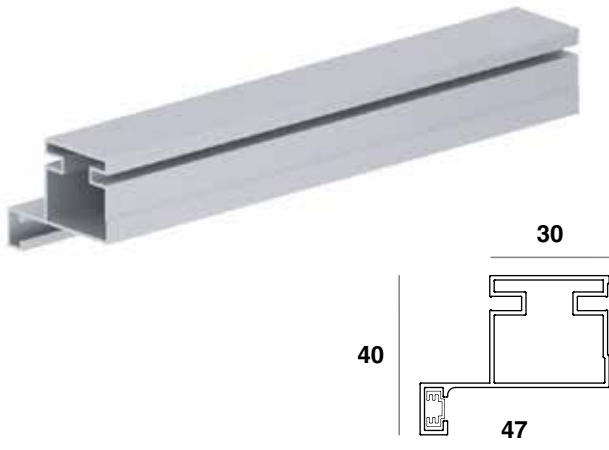

Ref.	Descripción	
755.2400	Perfil vertical 1 puerta 2,4 metros	10
755 PVC	Cubierta LED 2,4 metros *Incluida en perfil	10

Ref.	Descripción	
756.2400	Perfil vertical 2 puertas 2,4 metros *Cubierta incluida en perfil	10

Acabados Finishes

06	08	31	63
Lacado blanco White	Lacado negro Black	Anonizado plata Anodized silver	Lacado gris Grey

Acabados Finishes

06	08	31	63
Lacado blanco White	Lacado negro Black	Anonizado plata Anodized silver	Lacado gris Grey



sc herrajes®



Unique

03

03. Unique



901 ZAMAK

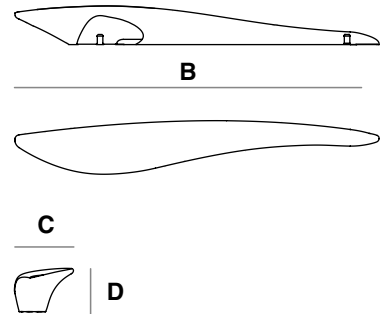

Acabados Finishes

04



Cromo brillo
Bright chrome

xx



Otros acabados
Other finishes

Ref.

901. 96

901.160

A

96

160

B

144

230

C

33

33

D

24

24



15

15

60

45



902 ZAMAK

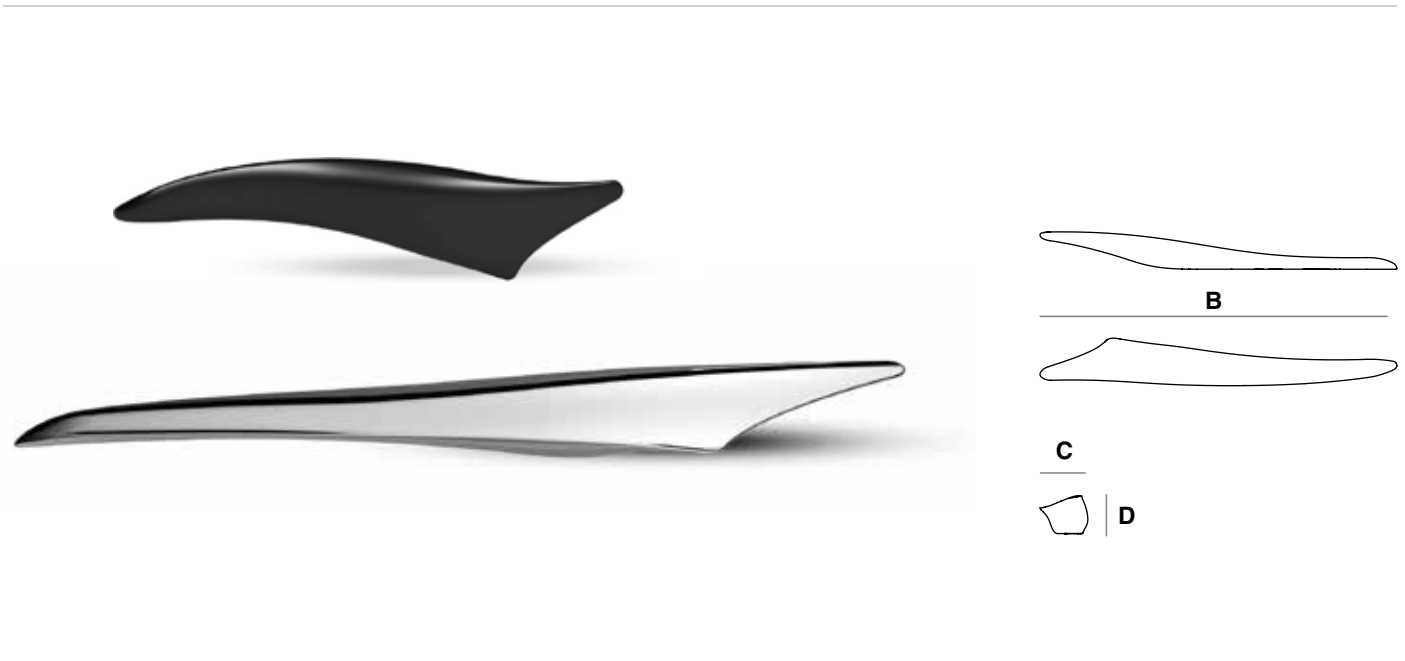

Acabados Finishes

04



Cromo brillo
Bright chrome

xx



Otros acabados
Other finishes

Ref.

902. 64

902.128

A

64

128

B

139

256

C

30

30

D

27

27



15

15

60

45

03. Unique



903 ZAMAK



B

C



D

Acabados Finishes

04



Cromo brillo
Bright chrome

xx



Otros acabados
Other finishes

Ref.

903. 64

903.128

A

64

128

B

123

243

C

41

41

D

25

30



15

15

60

45



904 ZAMAK

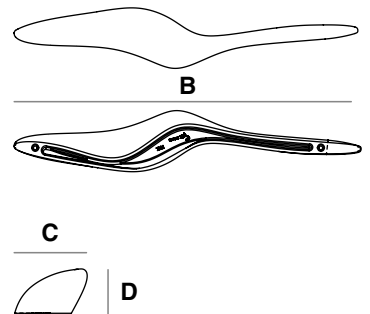

Acabados Finishes

04



Cromo brillo
Bright chrome

xx



Otros acabados
Other finishes

Ref.

904. 96

904.192

A

96

192

B

144

233

C

24

25

D

-

-



15

15

60

45

03. Unique

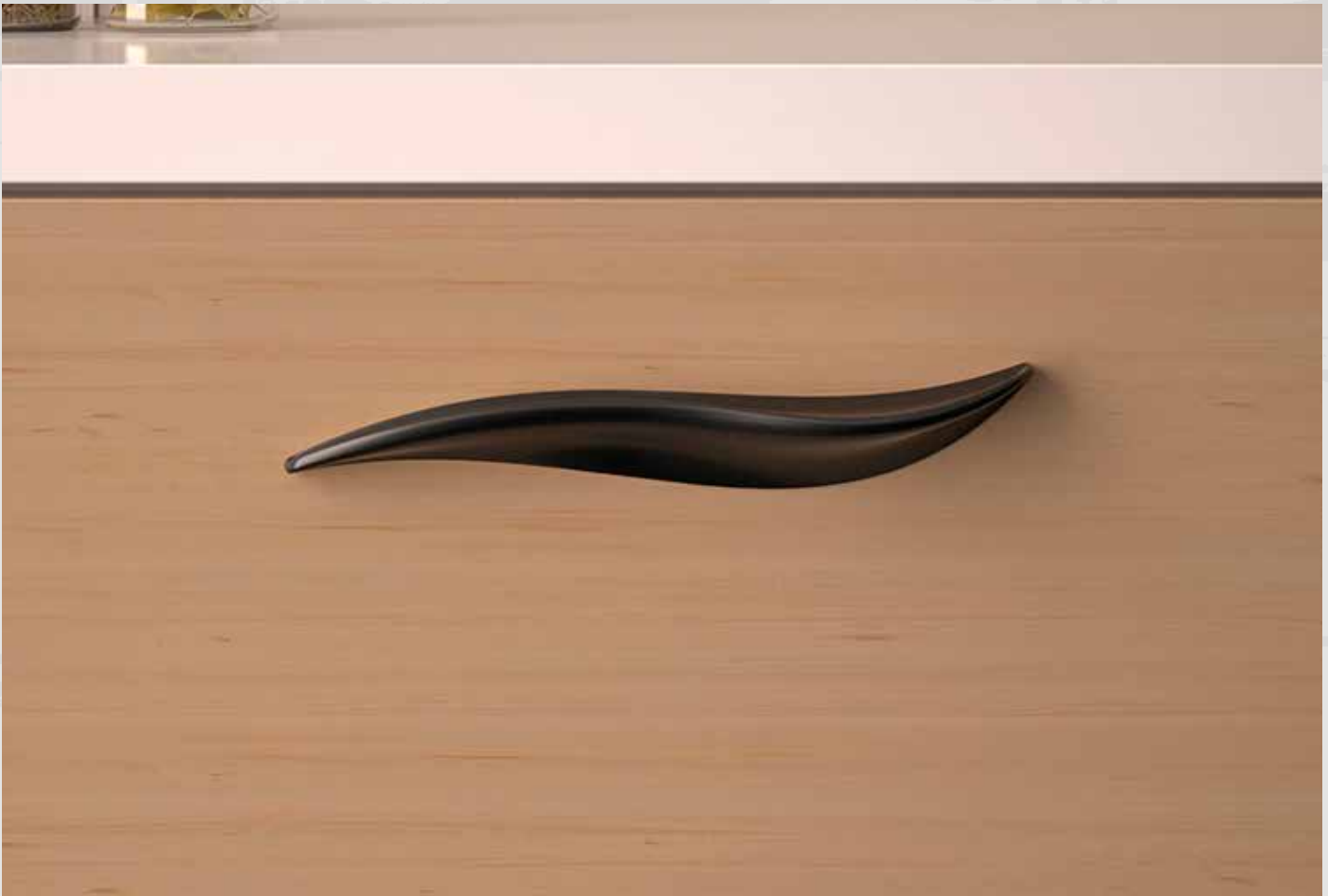

905 ZAMAK

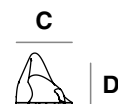
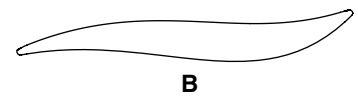

Acabados Finishes

04



Cromo brillo
Bright chrome

xx



Otros acabados
Other finishes

Ref.

905. 96

905.160

A

96

160

B

188

230

C

29

33

D

-

24



15

15

60

45



sc herrajes*

Diseño, pasión y Perfección

DESIGN. PASSION. PERFECTION. **Rubén García**

En SC la creatividad y la innovación continua son la clave para crear nuestra colección de tiradores exclusiva.

Siempre tras las tendencias de vanguardia en el diseño de interiores, nuestro objetivo es inspirar los entornos más únicos combinando las últimas tecnologías con las formas y los acabados más novedosos.

In SC, the creativity and continuous innovation are the keys to creating our collection of exclusive handles.

Always aiming to cutting-edge trends in interior design, our goal is to inspire the most unique environments, combining the latest technologies with the newest shapes and finishes.

Habla claro, te escuchamos

TALK TO US, WE LISTEN. **José Antonio Pérez**

En SC sabemos que la comunicación es el pilar básico de la confianza. Por ello, nuestra red comercial permite un entendimiento personalizado y directo con nuestros clientes.

Entendemos tus necesidades y queremos aportar nuestra experiencia y profesionalidad para dar con las soluciones y productos que cumplan con tus expectativas.

In SC we know that communication is the cornerstone of trust. Therefore, our sales network enables personal and direct understanding with our clients.

We understand your needs and we want to bring our experience and expertise to provide the solutions and products that meet your expectations.



sc herrajes®



Cuando la calidad es un hábito, el éxito es la consecuencia

WHERE QUALITY IS A HABIT, SUCCESS IS THE RESULT.

Miguel Ángel López

Con el certificado de calidad AENOR desde 2004 y una amplia gama de diseños registrados queremos ofrecer la seguridad y confianza que necesitas para marcar la diferencia frente a

la competitividad del mercado actual.

With the AENOR quality certificate since 2004 and a wide range of patented designs, we offer the security and confidence you need in front of the competitiveness of the nowadays market.



Conocemos los límites para poder superarlos

TALK TO US, WE LISTEN.

Humberto Gómez

Con origen en España, hoy en día SC sirve diseños de alta calidad por todo el mundo con la convicción de ofrecer un servicio profesional incluso en los mercados más exigentes.

Día a día, ponemos nuestro empeño en convertirnos en un referente mundial en la innovación y el diseño de complementos para el mueble.

With origins in Spain, SC serves top-quality designs all over the world with the conviction to offer a professional service even in the most demanding markets.

Every day, we put our emphasis on becoming a world leader in innovation and design accessories for furniture.

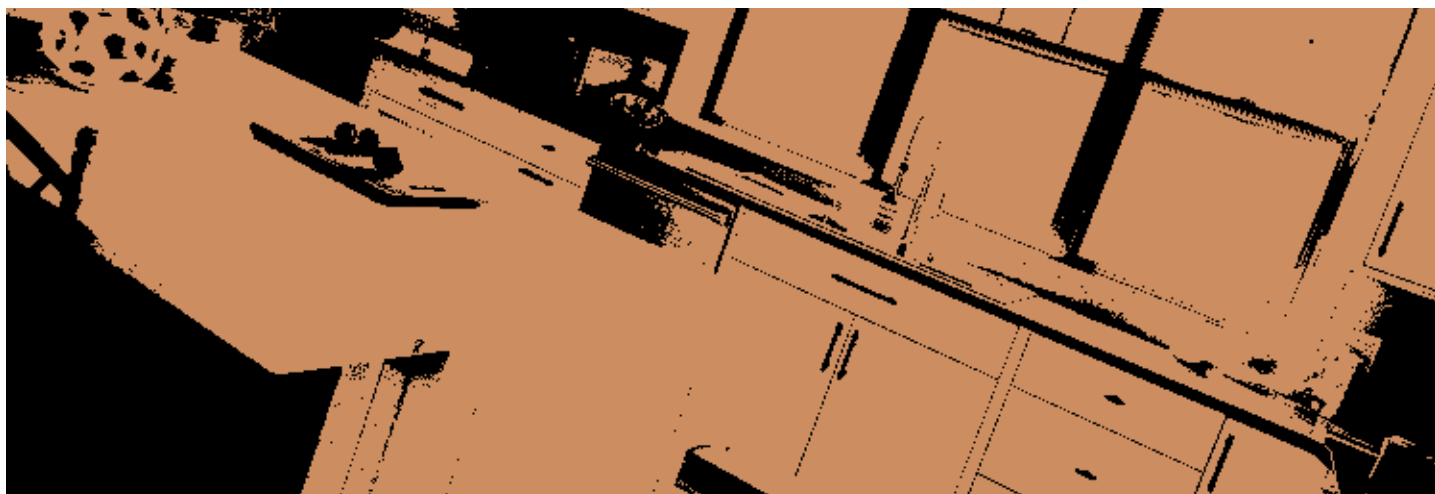



sc herrajes®



Essentials

04



sc herrajes®

Combina y crea
tu propio
tirador



PEPE RODRÍGUEZ

El actual presentador de MasterChef y propietario de uno de los restaurantes más conocidos de España, es también un gran entusiasta de los diseños de SC Herrajes, empresa a la que le une una estrecha amistad.

SC Herrajes y El Bohío comparten la filosofía del saber hacer, el cuidado por el detalle y la búsqueda de la máxima calidad y perfección. Como el mismo Pepe dice: "un producto tiene que ser bonito por fuera, pero tener calidad por dentro"

En El Bohío, se aprecia el valor del diseño, y por ello Pepe utiliza modelos de tiradores SC para presentar los platos y bocados más vanguardistas en su restaurante.

04. Essentials



850 ZAMAK

Sistema de fácil montaje por presión



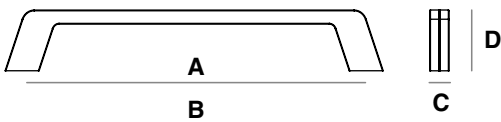







*Cada tirador está compuesto por dos mitades que se sirven desmontadas



Ref.	A	B	C	D		
850.160	160	178	12	26	25	100
850.256	256	274	12	26	25	75

Tirador combinable, se sirve desmontado

Acabados Finishes

03	04	05	06	08	58	60	xx
							
Provenzal Antique Brass	Cromo brillo Bright chrome	Plata vieja Antique silver	Lacado blanco White	Lacado negro Black	Níquel satinado Brush Satin Nickel	Titanio Titanium	Otros acabados Other finishes



*Los acabados hacen referencia sólo a medio tirador

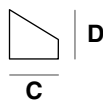
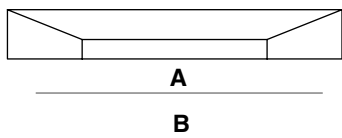

04. Essentials

843 ZAMAK



Ref.	A	B	C	D		
843. 96	96	145	20	20	40	160
843.160	160	218	20	20	25	100
843.256	256	327	20	20	25	75

Acabados Finishes



03
Provenzal
Antique Brass



04
Cromo brillo
Bright chrome



05
Plata vieja
Antique silver



08
Lacado negro
Black



58
Níquel satinado
Brush Satin Nickel



04. Essentials



844 ZAMAK

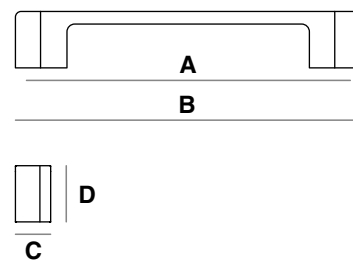

Acabados Finishes

04

Cromo brillo
Bright chrome

05

Plata vieja
Antique silver

08

Lacado negro
Black

58

Niquel satinado
Brush Satin Nickel

Ref.

844.128

844.192

844.256

A

128

192

256

B

149

213

277

C

15

15

15

D

25

25

25



40

30

30

160

120

120



845 ZAMAK

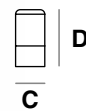
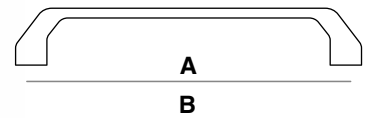

Acabados Finishes

04

Cromo brillo
Bright chrome

58

Niquel satinado
Brush Satin Nickel

Ref.

845.128
845.192
845.256

A

128
192
256

B

136
200
264

C

12
12
12

D

26
26
26



40

160

30

120

30

120

04. Essentials

839 ZAMAK

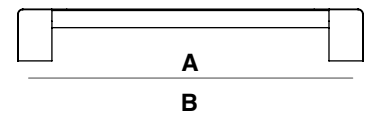

Acabados Finishes

04



Cromo brillo
Bright chrome

08



Lacado negro
Black

58



Níquel satinado
Brush Satin Nickel

Ref.

839.192

839.320

A

192

320

B

202

330

C

12

12

D

30

30



30

20

90

60

*Tirador combinado 2 acabados

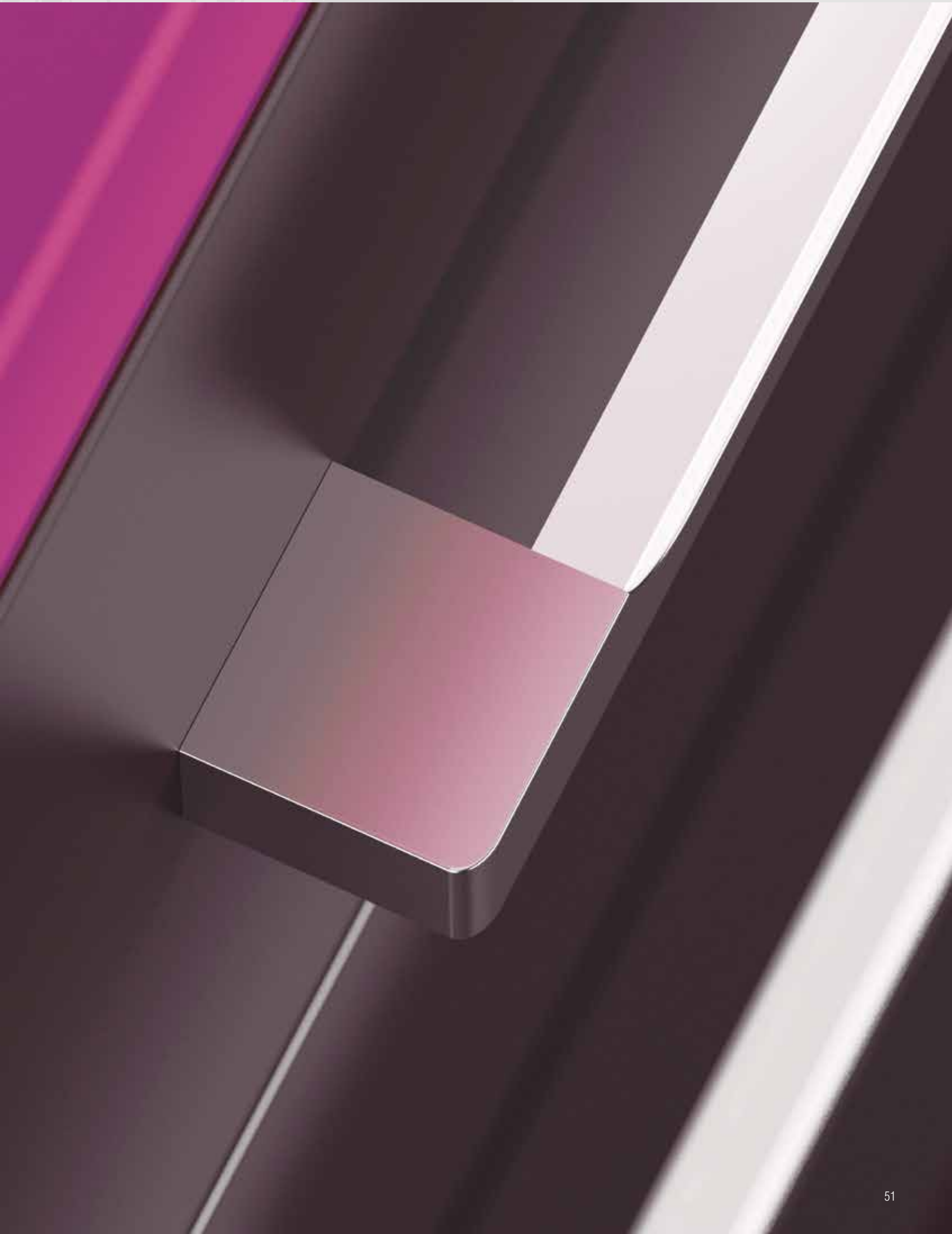

04. Essentials



842 ZAMAK

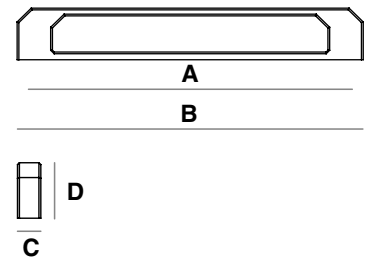
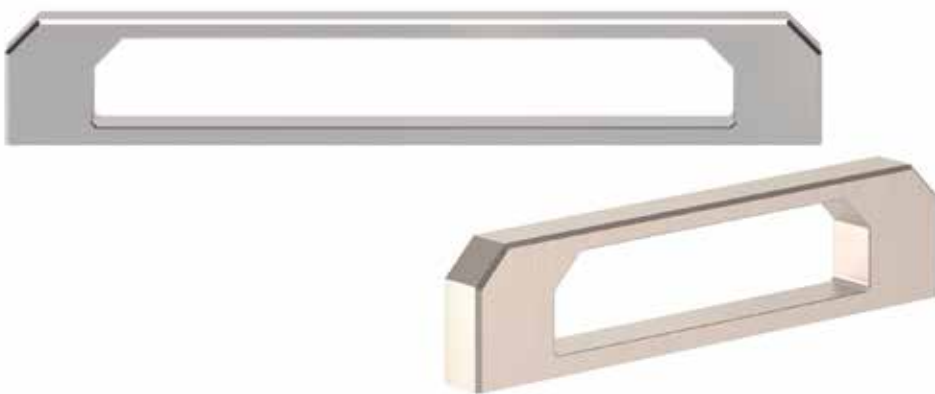

Acabados Finishes

04



Cromo brillo
Bright chrome

58



Níquel satinado
Brush Satin Nickel

Ref.

842. 96

842.160

A

96

160

B

132

196

C

12

12

D

30

30



40

40

160

120



837 ZAMAK

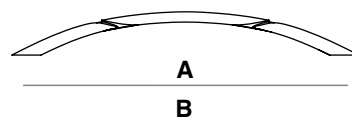

Acabados Finishes

04



Cromo brillo
Bright chrome

58



Níquel satinado
Brush Satin Nickel

PVC



Blanco
White



Negro
Black

Ref.

837.192

837.256

A

192

256

B

202

266

C

18

18

D

32

32



40

40

120

120

04. Essentials



836 ZAMAK

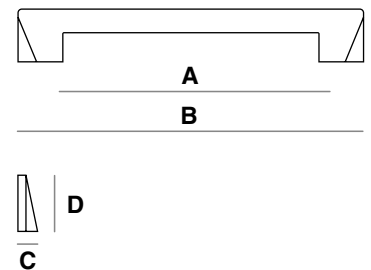

Acabados Finishes

04



Cromo brillo
Bright chrome

58



Níquel satinado
Brush Satin Nickel

Ref.

836.128

836.192

836.320

A

128

B

150

C

10

D

35



60

180

50

150

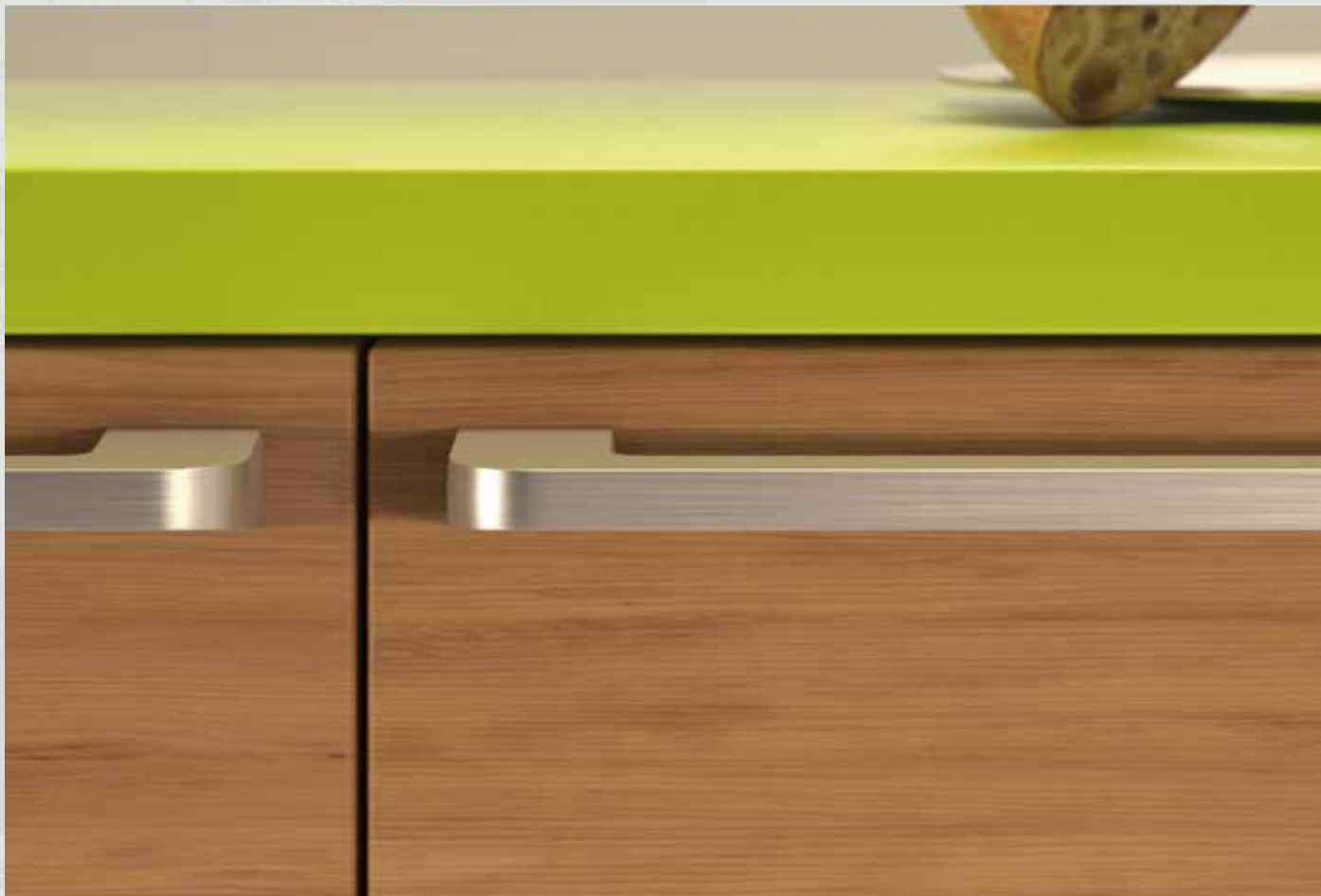

30

90



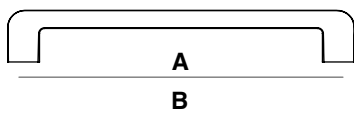





835 ZAMAK



Ref.	A	B	C	D		
835.192	192	211	12	33	25	75
835.256	256	275	12	33	25	75

Acabados Finishes

04	06	08	10	12	58	60
						
Cromo brillo Bright chrome	Lacado blanco White	Lacado negro Black	Lacado gris Grey	Lacado arena Sand	Níquel satinado Brush Satin Nickel	Titanio Titanium

*Consultar medidas disponibles en acabados SC MATT



04. Essentials



834 ZAMAK

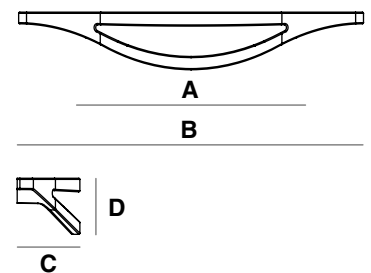

Acabados Finishes

04

 **Cromo brillo**
Bright chrome

58

 **Níquel satinado**
Brush Satin Nickel

Ref.

834. 96

834.160

834.256

A

96

160

256

B

150

250

400

C

25

28

32

D

20

25

30



25

30

25

100

120

75

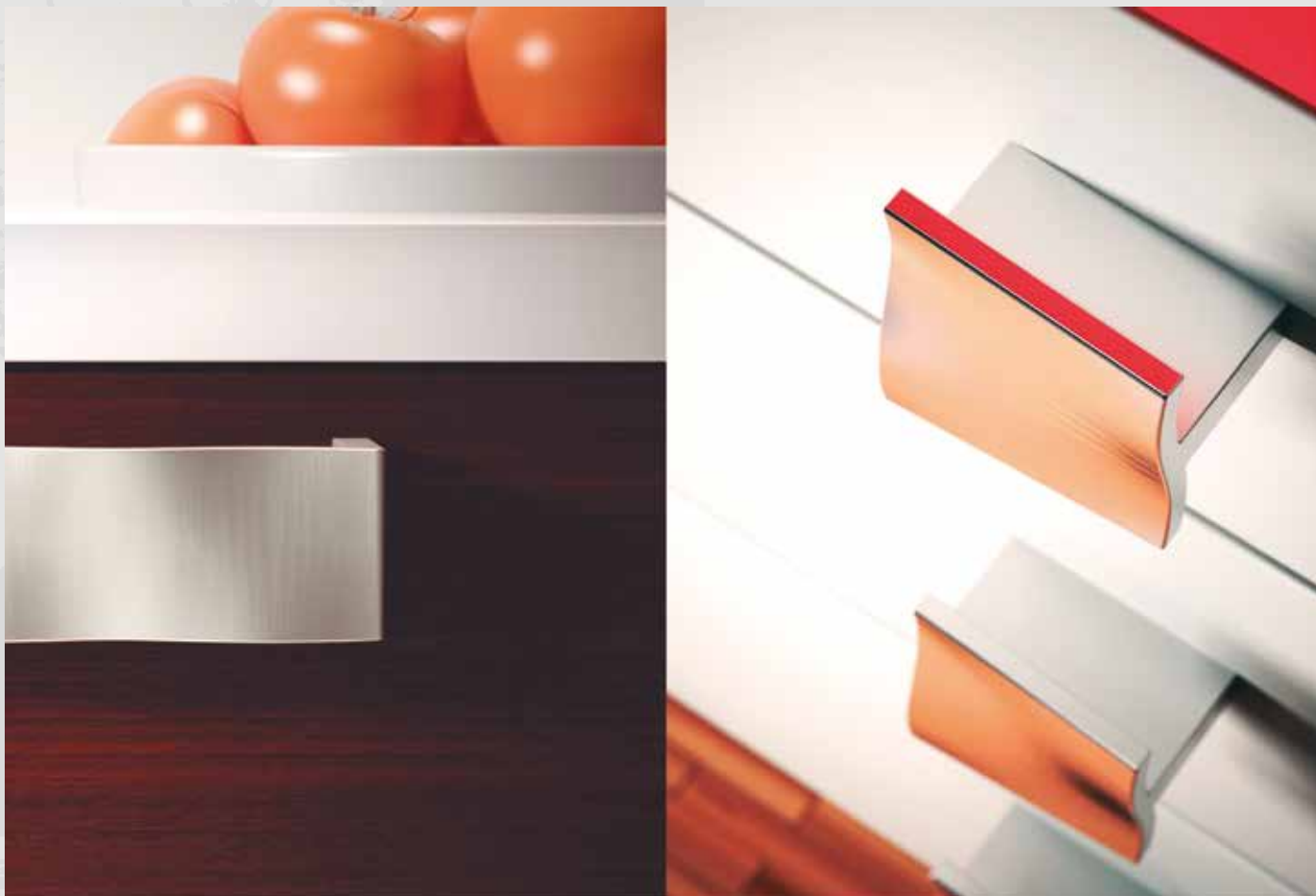

832 ZAMAK

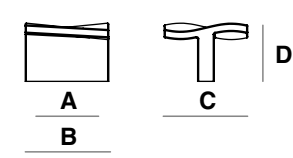
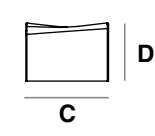
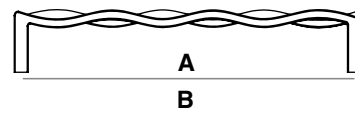

Acabados Finishes

04



 Cromo brillo
Bright chrome

58

 Niquel satinado
Brush Satin Nickel

Ref.

832. 32
832.192

A	B	C	D		
32	40	40	28	25	75
192	200	40	28	25	100

04. Essentials



830 ZAMAK

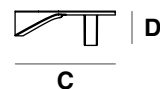
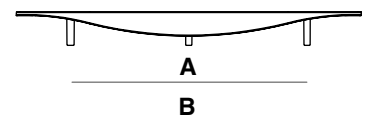

Acabados Finishes

04

Cromo brillo
Bright chrome

58

Niquel satinado
Brush Satin Nickel

Ref.

830.146

830.280

830.446

A

96

192

384

B

146

280

446

C

39

39

39

D

10

10

10



25

25

25

100

75

75



829 ZAMAK

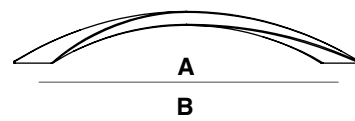

Acabados Finishes

04



Cromo brillo
Bright chrome

05



Plata vieja
Antique silver

58



Níquel satinado
Brush Satin Nickel

Ref.

829.128

829.192

829.256

A

128

B

175

C

20

D

28



40

160

40

160

25

75

04. Essentials



824 ZAMAK

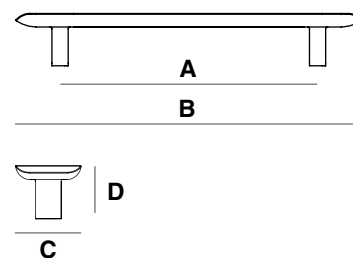

Acabados Finishes

04



Cromo brillo
Bright chrome

08



Lacado negro
Black

58



Niquel satinado
Brush Satin Nickel

Ref.

824.160

824.224

A

160

224

B

208

272

C

36

36

D

29

29



25

25

100

100

*Tirador combinado 2 acabados



828 ZAMAK

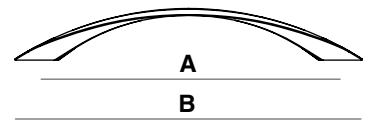

Acabados Finishes

04



Cromo brillo
Bright chrome

08



Lacado negro
Black

58



Niquel satinado
Brush Satin Nickel

Ref.

828.192

A

192

B

232

C

26

D

34



25



100



*Tirador combinado 2 acabados

04. Essentials



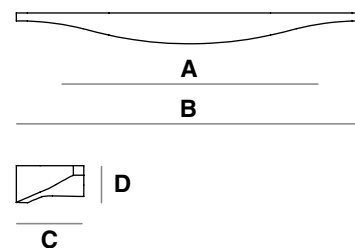





825 ZAMAK



Ref.	A	B	C	D		
825. 64	64	145	18	10	25	100
825.160	160	280	20	10	25	75
825.256	256	446	20	11	25	75

Acabados Finishes

04	06	08	10	12	58	60
						
Cromo brillo Bright chrome	Lacado blanco White	Lacado negro Black	Lacado gris Grey	Lacado arena Sand	Niquel satinado Brush Satin Nickel	Titanio Titanium

*Consultar medidas disponibles en acabados **SC MATT**



04. Essentials

818 ZAMAK

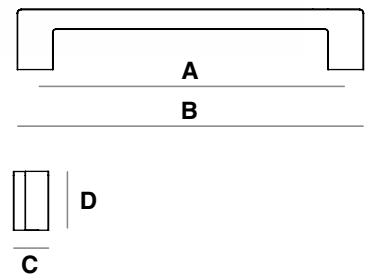

Acabados Finishes

04



Cromo brillo
Bright chrome

08



Lacado negro
Black

58



Níquel satinado
Brush Satin Nickel

Ref.

818.128

818.192

818.320

A

128

B

146

C

16

D

30



25

75

25

75

25

75

*Tirador combinado 2 acabados





04. Essentials



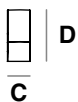
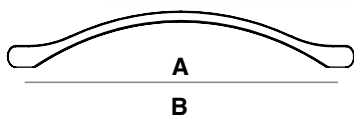









816 ZAMAK



Ref.	A	B	C	D		
816.128	128	144	10	26	50	200
816.192	192	215	10	26	25	75
816.256	256	280	10	26	25	75

Acabados Finishes

03	04	05	06	08	10	12	30	58	60
									
Provenzal Antique Brass	Cromo brillo Bright chrome	Plata vieja Antique silver	Lacado blanco White	Lacado negro Black	Lacado gris Grey	Lacado arena Sand	Cromo mate Matt Chrome	Níquel satinado Brush Satin Nickel	Titanio Titanium

*Consultar medidas disponibles en acabados **SC MATT**



815 ZAMAK



*PVC no incluido

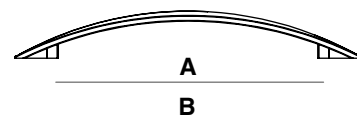

Acabados Finishes

04



Cromo brillo
Bright chrome

30



Cromo mate
Matt Chrome

58



Niquel satinado
Brush Satin Nickel

Ref.

815.128

815.192

A

128

192

B

162

256

C

27

32

D

38

38



25

25

75

75

04. Essentials



814 ZAMAK

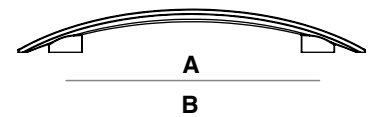

Acabados Finishes

04

Cromo brillo
Bright chrome

58

Níquel satinado
Brush Satin Nickel

Ref.

814.160

814.192

814.320

A

160

192

320

B

220

260

400

C

22

27

36

D

27

31

38



25

25

25

75

75

75



04. Essentials

378 ZAMAK

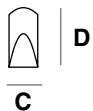
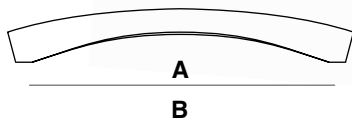
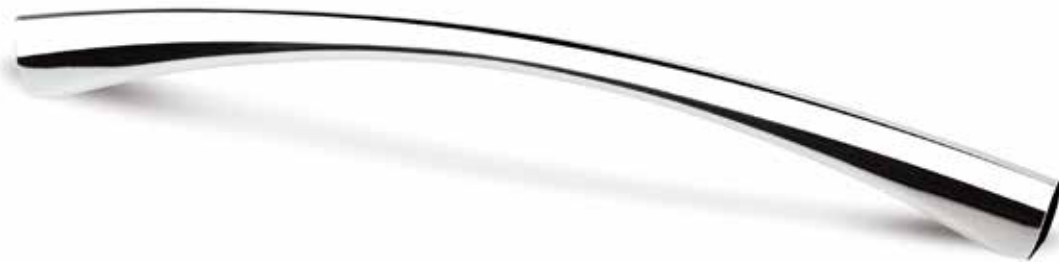

Acabados Finishes

04

Cromo brillo
Bright chrome

30

Cromo mate
Matt Chrome

58

Niquel satinado
Brush Satin Nickel

60

Titanio
Titanium

Ref.

378.160

378.192

378.256

378.384

A

160

192

256

384

B

175

210

280

408

C

13

14

14

14

D

29

32

35

38



30

25

25

25

90

75

75

75

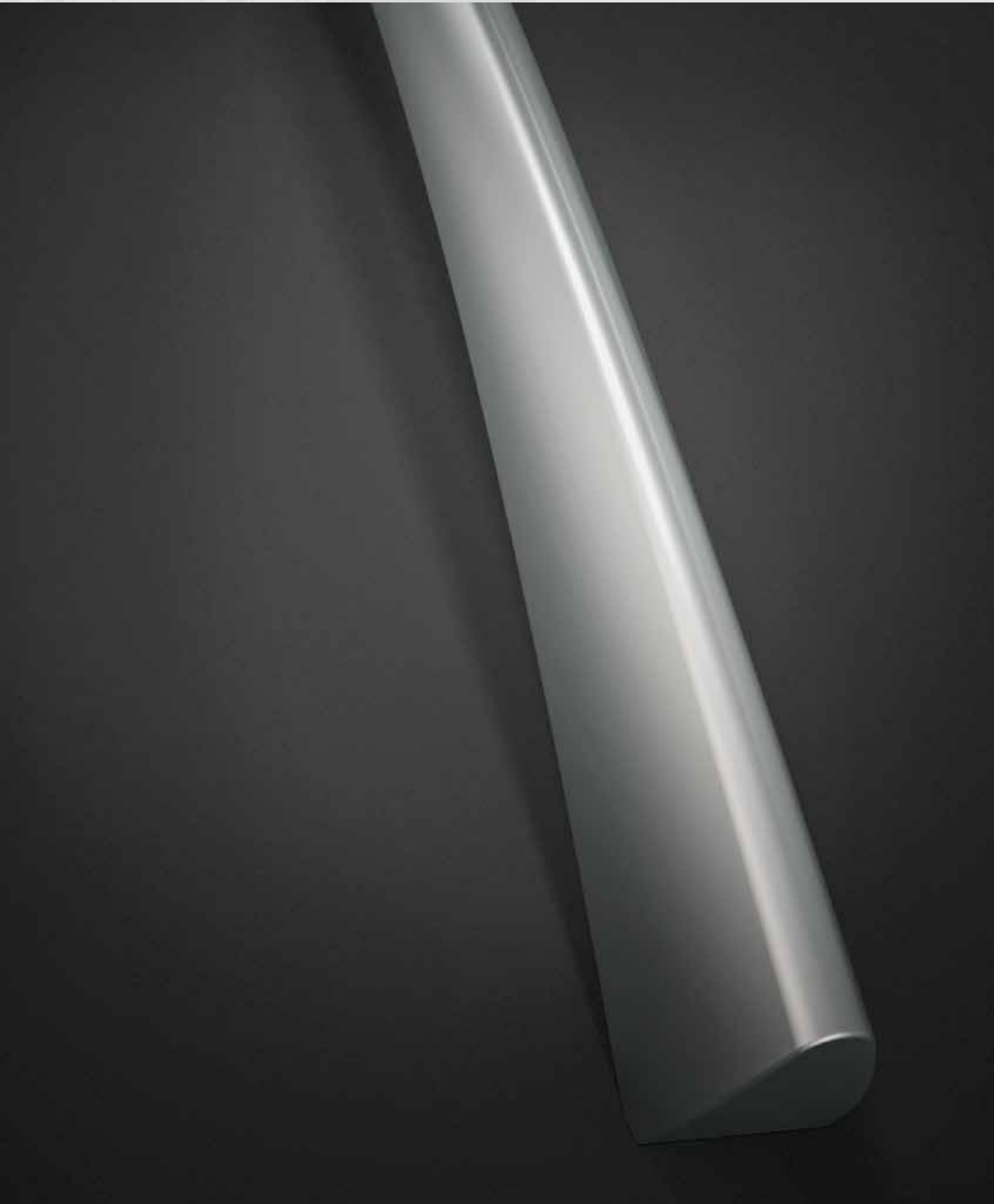

04. Essentials



373 ZAMAK

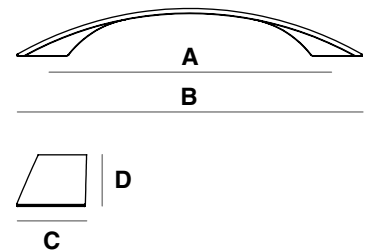

Acabados Finishes

04

 Cromo brillo
Bright chrome

30

 Cromo mate
Matt Chrome

58

 Niquel satinado
Brush Satin Nickel

Ref.

373.160

373.256

A

160

256

B

215

330

C

37

37

D

26

29



35

25

140

75



377 ZAMAK

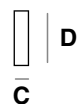
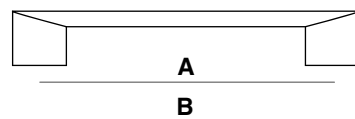

Acabados Finishes

04

Cromo brillo
Bright chrome

30

Cromo mate
Matt Chrome

58

Niquel satinado
Brush Satin Nickel

Ref.

377.160

377.192

377.240

377.352

A

B

C

D



Ref.	A	B	C	D		
377.160	160	187	7	30	25	100
377.192	192	226	7	33	30	90
377.240	240	280	8	35	25	75
377.352	352	400	8	35	25	75





04. Essentials

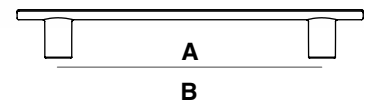



368 ZAMAK



Acabados Finishes

04	30	58	xx
			
Cromo brillo Bright chrome	Cromo mate Matt Chrome	Níquel satinado Brush Satin Nickel	Otros acabados Other finishes

Ref.	A	B	C	D		
368. 96	96	146	15	21	25	100
368.160	160	210	15	29	30	90
368.240	240	298	17	31	20	60
368.320	320	398	17	31	25	75

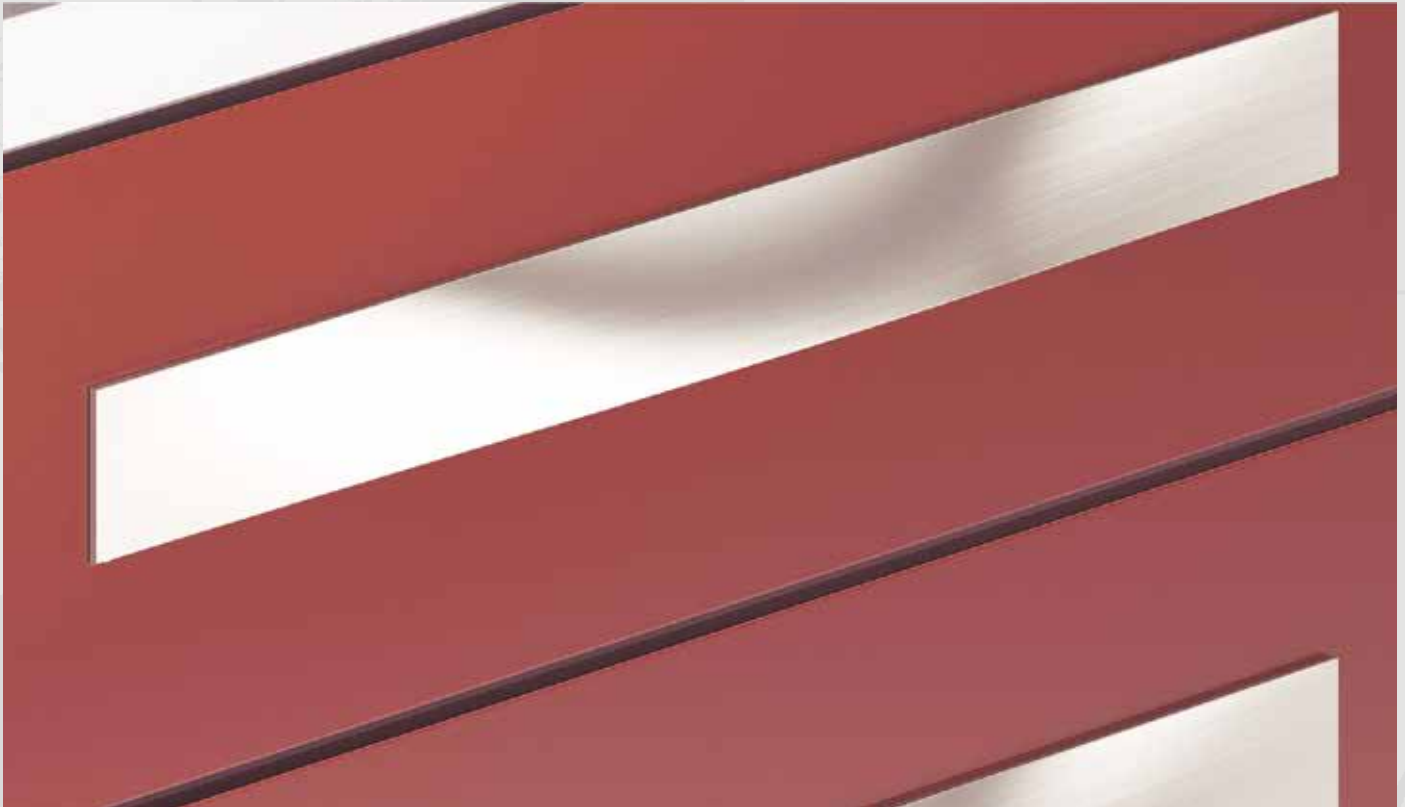

365 ZAMAK

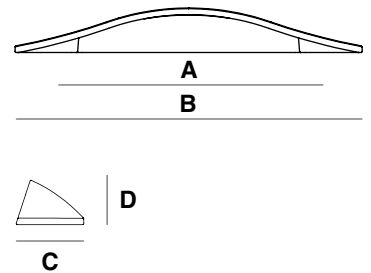

Acabados Finishes

04



Cromo brillo
Bright chrome

30



Cromo mate
Matt Chrome

58



Niquel satinado
Brush Satin Nickel

Ref.

365. 16

365. 64

365.128

365.224

A

16

64

128

224

B

40

135

190

380

C

40

40

40

40

D

16

19

22

24



25

25

25

25

100

75

75

75

04. Essentials



370 ZAMAK

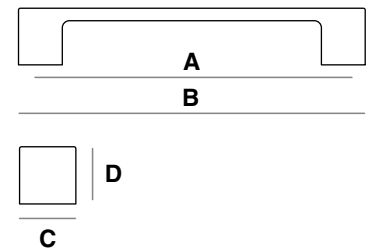

Acabados Finishes

04



Cromo brillo
Bright chrome

30



Cromo mate
Matt Chrome

58



Níquel satinado
Brush Satin Nickel

Ref.

370.128

370.160

370.192

A

128

B

168

C

24

D

28



25

75

25

75

25

100



305 ZAMAK

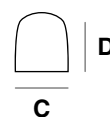
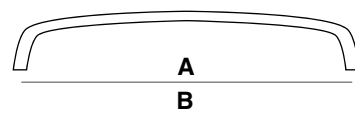

Acabados Finishes

04



Cromo brillo
Bright chrome

30



Cromo mate
Matt Chrome

58



Niquel satinado
Brush Satin Nickel

Ref.

305. 96

305.160

305.192

A

B

C

D



96

107

18

19

25

100

160

172

23

24

30

90

192

204

24

25

25

75

04. Essentials

813 ZAMAK

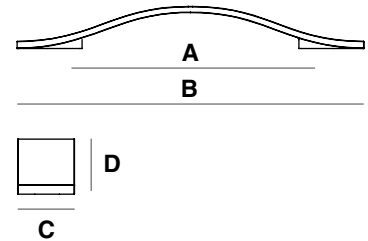

Acabados Finishes

04



Cromo brillo
Bright chrome

30



Cromo mate
Matt Chrome

58



Niquel satinado
Brush Satin Nickel

Ref.

813. 96

813.160

813.256

A

B

C

D



Ref.	A	B	C	D		
813. 96	96	170	25	18	25	75
813.160	160	240	30	29	25	75
813.256	256	380	32	36	12	36

327 INOX STEEL

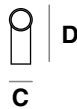
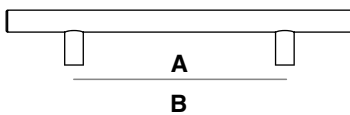

Ref.

Puerta

A

B

327.128

327.160

327.192

327.224

327.256

327.306

327.356

327.430

327.456

327.575

327.632

327.758

327.840

327.1105

-

-

-

300

350

400

400

550

550

700

800

900

1000

1200

128

160

192

224

256

306

356

430

456

575

632

758

840

1105

168

230

262

276

326

376

426

500

526

645

702

828

910

1175

Acabados Finishes

57



Efecto inox
Inox effect

Ref.

327.128

327.160

Resto

C

D



Ref.	C	D		
327.128	12	32	20	100
327.160	12	32	10	60
Resto	12	32	5	20

808 INOX STAINLESS STEEL 304

Ref.	A	B
808.96	96	108
808.128	128	140
808.160	160	172
808.192	192	204
808.288	288	300
808.292	292	304
808.320	320	342
808.392	392	404
808.442	442	454
808.492	492	504
808.542	542	554
808.592	592	604
808.692	692	704
808.742	742	754
808.992	992	1004

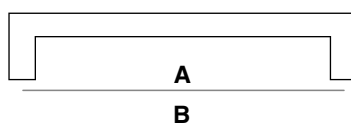

C	D
12	35



535 INOX STAINLESS STEEL 304

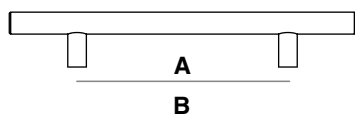

Ref.	Puerta	A	B
535.96	-	96	160
535.128	-	128	192
535.160	-	160	224
535.192	300	192	256
535.242	350	242	306
535.292	400	292	356
535.320	450	320	384
535.342	450	342	406
535.392	500	392	456
535.442	550	442	506
535.492	600	492	556
535.592	700	592	656
535.692	800	692	756
535.792	900	792	856
535.892*	1000	892	956
535.1092*	1200	1092	1156
535.1192*	1300	1192	1256
535.1392*	1500	1392	1456

*medidas de puerta 1000, 1200, 1300 y 1500 disponen de pata central

C	D
14	35



Acabados Finishes

57





Efecto inox
Inox effect

04. Essentials

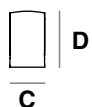
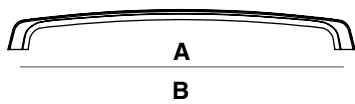

374 ZAMAK

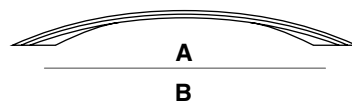

Ref.	A	B	C	D		
374.192	192	210	10	26	25	75
374.240	240	258	10	28	25	75

375 ZAMAK



Ref.	A	B	C	D		
375.192	192	240	15	24	25	75

367 ZAMAK

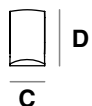
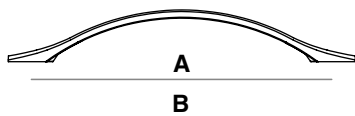

Acabados Finishes

04



Cromo brillo
Bright chrome

30





Cromo mate
Matt Chrome

58





Niquel satinado
Brush Satin Nickel

Ref.	A	B	C	D		
367.128	128	171	18	26	25	75
367.160	160	203	20	29	25	75

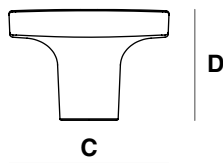

240 ZAMAK

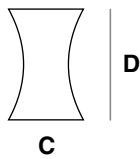
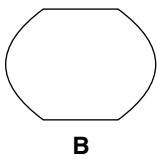

Ref.	A	B	C	D		
240. 24	-	24	-	20	80	240
240. 32	-	32	-	26	80	240

807 ZAMAK



Ref.	A	B	C	D		
807. 40	-	40	20	30	60	180

576 ZAMAK

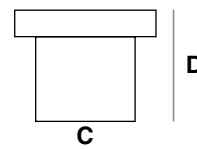
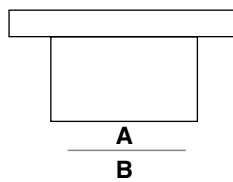

Acabados Finishes

04



Cromo brillo
Bright chrome

30

Cromo mate
Matt Chrome

58

Niquel satinado
Brush Satin Nickel

Ref.	A	B	C	D		
576. 44	16	44	27	21	25	100

04. Essentials

ALUMINIO 704



Acabados Finishes

04



31

 Cromo brillo
Bright chrome

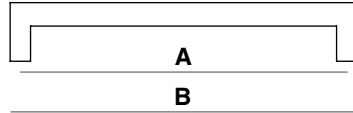
 Anodizado plata
Anodized silver



Ref.	A	B
704.140	128	140
704.204	192	204
704.292	280	292
704.392	380	392
704.592	580	592
704.792	780	792

C	D		
12	30	20	60

ALUMINIO 702





Acabados Finishes

04

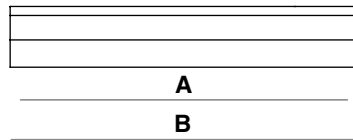
 Cromo brillo
Bright chrome



Ref.	A	B
702.150	96	150
702.200	160	200
702.300	256	300
702.400	320	400
702.600	240*480	600
702.800	320*640	800

C	D		
8	20	25	75

ALUMINIO 701



Acabados Finishes

04

31

 Cromo brillo
Bright chrome

 Anodizado plata
Anodized silver

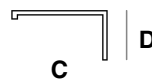
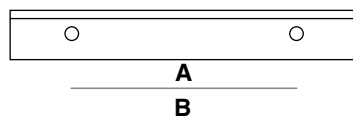

Ref.	A	B
701.45	32	45
701.104	64	104
701.168	96	168
701.200	128	200

C	D		
42	20	20	60

ALUMINIO 392

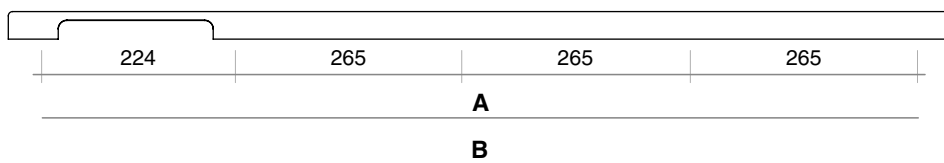
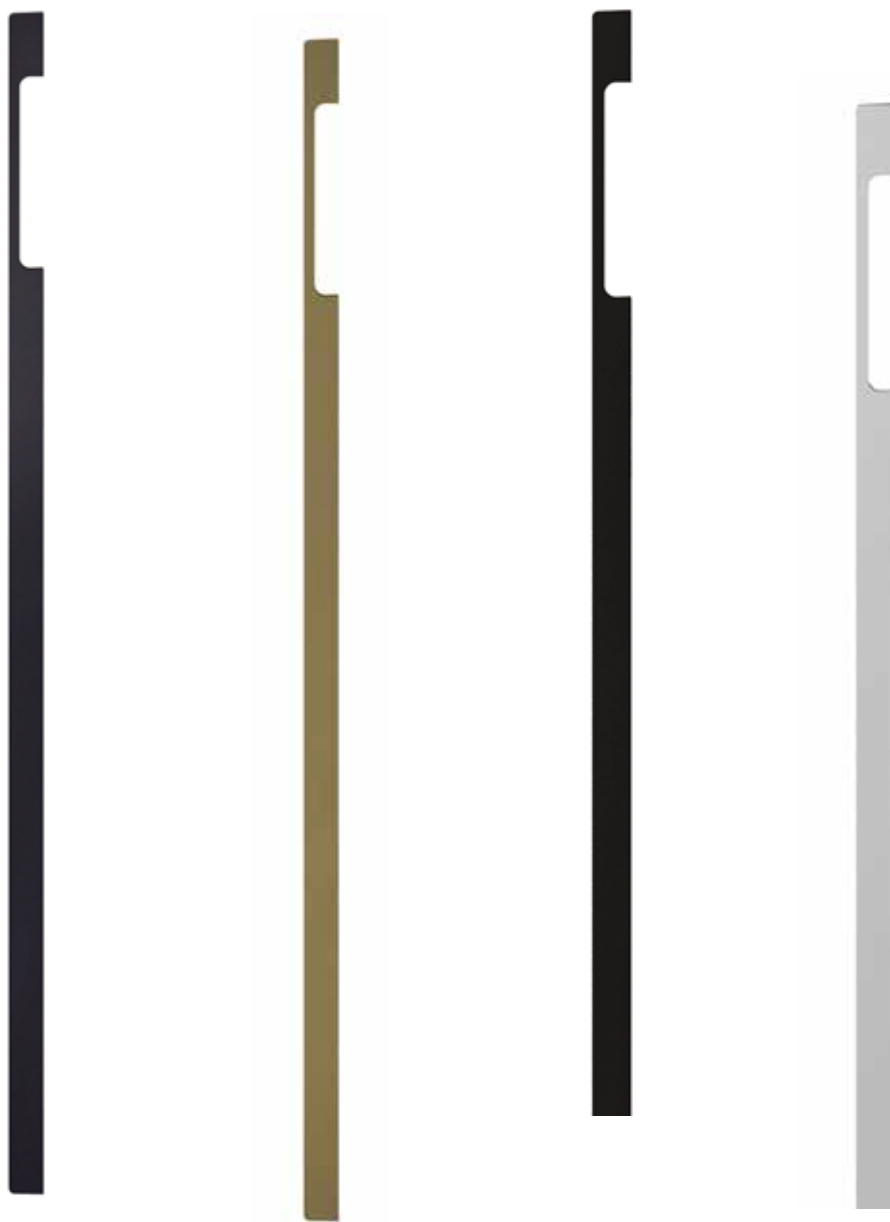

D
C

Acabados Finishes

06	08	60	xx
Lacado blanco White	Lacado negro Black	Titanio Titanium	Otros acabados Other finishes

Ref.
392. 1096

A	B	C	D		
-	1096	8	32	5	20

04. Essentials

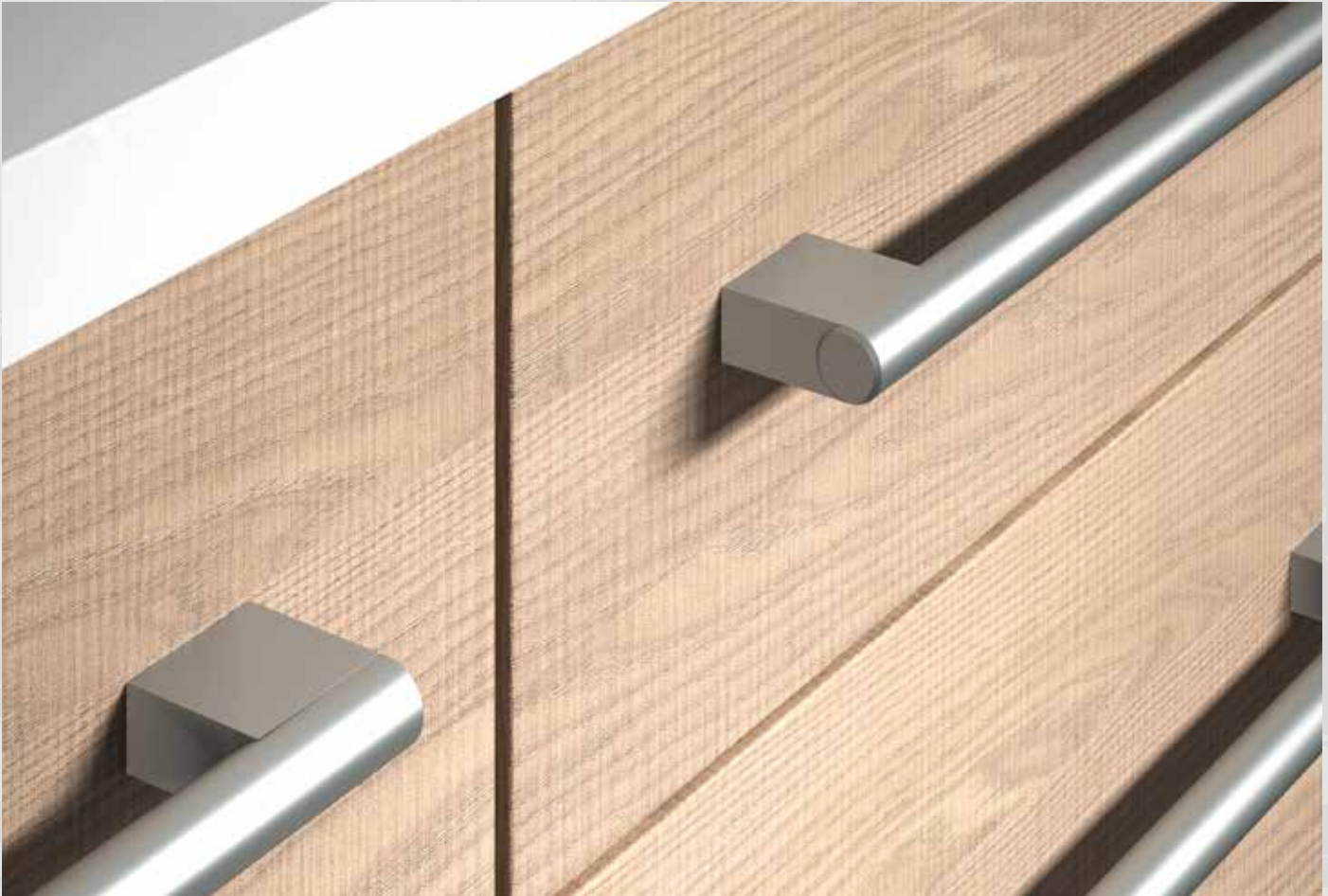

389 ALUMINIO



Ref.	A	B
389.192	192	212
389.392	392	312
389.492	492	512
389.592	592	612
389.692	692	712

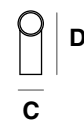
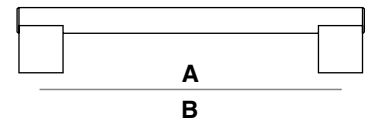



Acabados Finishes

31



Anonizado plata
Anodized silver

C	D		
14	44	20	60



385 ALUMINIO

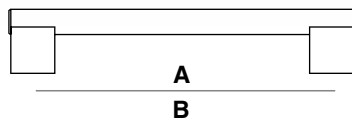

Ref.	Puerta	A	B
385.128	200	128	148
385.160	250	160	180
385.192	300	192	212
385.242	350	242	262
385.292	400	292	312
385.342	450	342	362
385.392	500	392	412
385.492	600	492	512
385.592	700	592	612
385.692	800	692	712
385.792	900	792	812
385.892*	1000	992	912
385.992*	1200	1092	1112
385.1092*			

*medidas de puerta 1000, 1200, 1300 y 1500 disponen de pata central

Acabados Finishes

31

Anonizado plata
 Anodized silver

C	D		
16	36	15	45



sc herrajes®

FUSIÓN



05

05. Fusión





841 ZAMAK



Acabados Finishes

04	08	58
 Cromo brillo Bright chrome	 Lacado negro Black	 Níquel satinado Brush Satin Nickel

Ref.

841.160	A	B	C	D		
	160	210	18	34	40	120





831 ZAMAK



Acabados Finishes

04	08	30	58
			
Cromo brillo Bright chrome	Lacado negro Black	Cromo mate Matt Chrome	Níquel satinado Brush Satin Nickel

Ref.

831.250	A	B	C	c	D		
	160	248	20,5	1,5	36	20	80

05. Fusión



827 ZAMAK

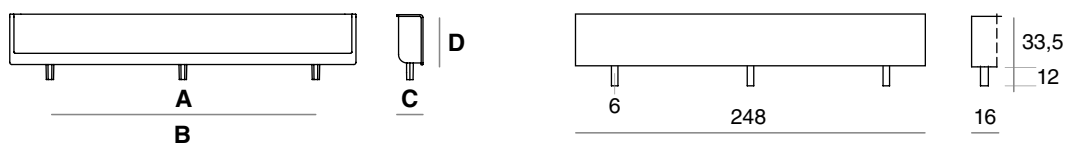

Acabados Finishes

04

XX

 Cromo brillo
Bright chrome

 Otros acabados
Other finishes

Ref.

827.250

A

-

B

250

C

19

D

36



25



100



826 ZAMAK

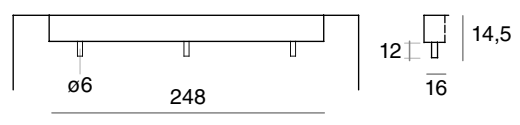
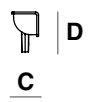
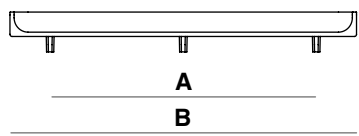

Acabados Finishes

04

XX

 Cromo brillo
Bright chrome

 Otros acabados
Other finishes

Ref.

826.250

A

96-192

B

250

C

19

D

17



25

75

05. Fusión

819 ZAMAK

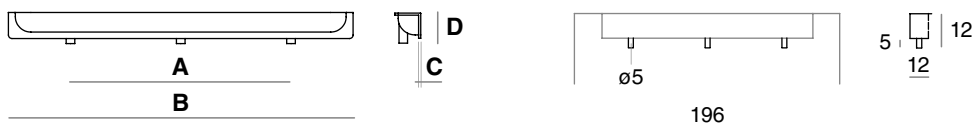

Acabados Finishes

04	30	60	XX
Cromo brillo Bright chrome	Cromo mate Matt Chrome	Titanio Titanium	Otros acabados Other finishes

Ref.	A	B	C	D		
819.100	64-128	100	1,25	15	25	75
819.200	64-128	200	1,25	15	25	75

820 ZAMAK

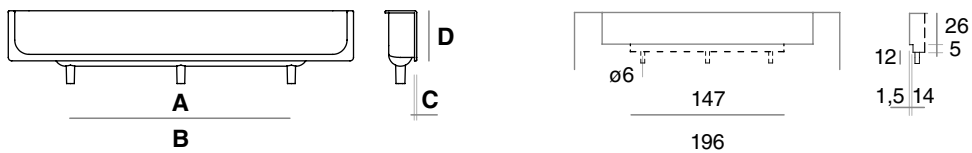

Acabados Finishes

04	30	XX
Cromo brillo Bright chrome	Cromo mate Matt Chrome	Otros acabados Other finishes

Ref.	A	B	C	D		
820.200	200	1,25	28	-	25	75



582 ZAMAK



Acabados Finishes

04

58

Cromo brillo
Bright chrome

Níquel satinado
Brush Satin Nickel

Ref.

582. 96

582.192

A

B

C

D



96

106

15

51

25

75

192

202

15

51

25

100



sc herrajes®



CLASSIC

06

06. Classic



851 ZAMAK

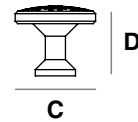
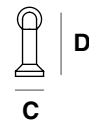
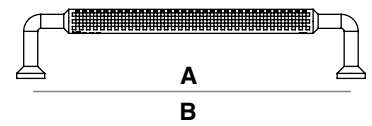
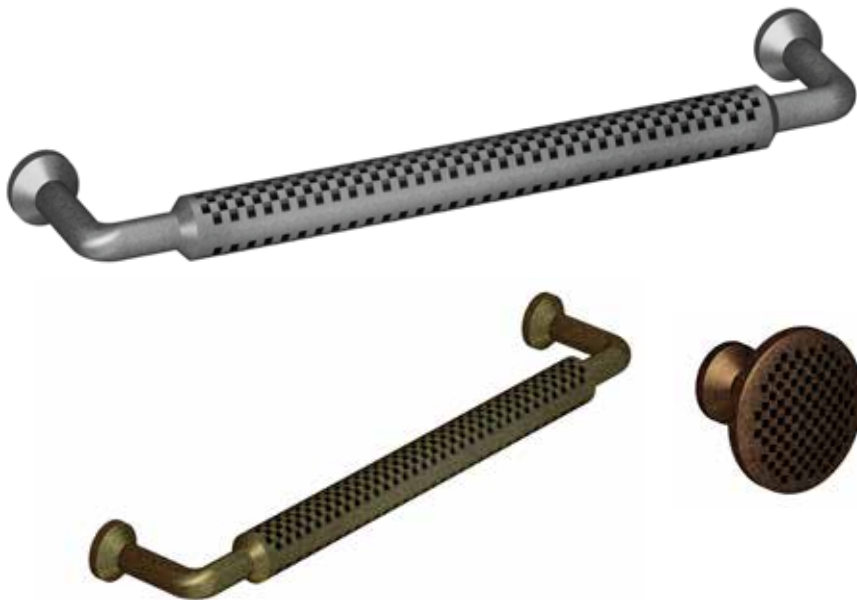

Acabados Finishes

03



Provenzal
Antique Brass

05



Plata vieja
Antique silver

98



Cobre viejo
Antique Copper

Ref.

851. 32

851.160

A

-

160

B

-

174

C

32 Ø

14 Ø

D

28

35



50

20

200

80



06. Classic



852 ZAMAK

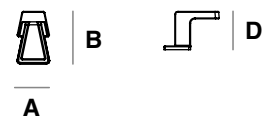
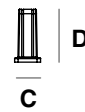
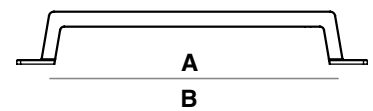
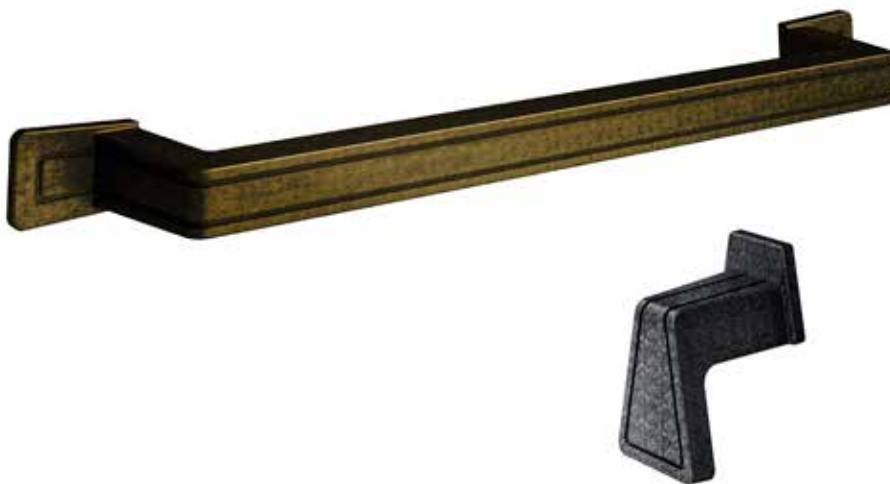

Acabados Finishes

03



Provenzal
Antique Brass

05



Plata vieja
Antique silver

98



Cobre viejo
Antique Copper

Ref.

852. 25

852.160

A

25

160

B

35

194

C

-

15

D

26

30



50

20

200

80



06. Classic



846 ZAMAK

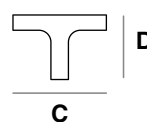
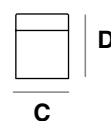
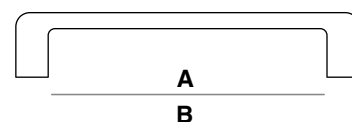

Acabados Finishes

03

●
Provenzal
Antique Brass

05

●
Plata vieja
Antique silver

98

●
Cobre viejo
Antique Copper

Ref.

846. 36

846.160

846. 36

846.160

A

16

160

16

160

B

36

173

36

173

C

36

24

36

24

D

28

28

28

28



50

30

20

25

150

120

60

75



348 ZAMAK

349 ZAMAK

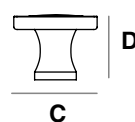
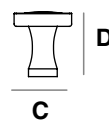
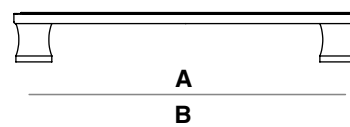

Acabados Finishes

03

 Provenzal
Antique Brass

05

 Plata vieja
Antique silver

98

 Cobre viejo
Antique Copper

Ref.

348.128

349. 36

349. 55

A

128-160

16

16

B

170

35

55

C

24

-

-

D

26

28

30



20

25

25

60

75

75

06. Classic



847 ZAMAK

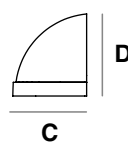
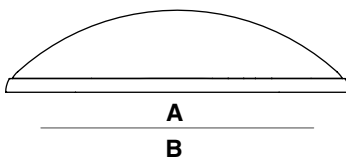
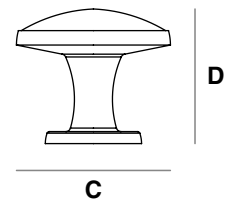

Ref.

847. 96

847. 32

A

B

C

D

96

114

28

31

20

80

-

-

32

28

50

200

Acabados Finishes

03



Provenzal
Antique Brass

04



Cromo brillo
Bright chrome

05



Plata vieja
Antique silver

06



Lacado blanco
White

08



Lacado negro
Black

58



Níquel satinado
Brush Satin Nickel

XX



Otros acabados
Other finishes



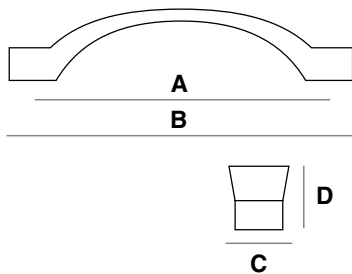

06. Classic

347 ZAMAK



Ref.
347. 96

A	B	C	D		
96	117	23	24	25	75

345 ZAMAK

346 ZAMAK

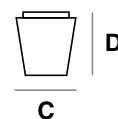
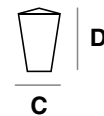
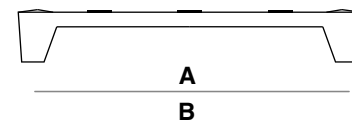

Acabados Finishes

03

 Provenzal
Antique Brass

05

 Plata vieja
Antique silver

98

 Cobre viejo
Antique Copper

Ref.
345.160

A	B	C	D		
160	179	29	27	25	75

346. 22

-	-	22	25	25	75
---	---	----	----	----	----



556 ZAMAK

557 ZAMAK



Acabados Finishes	
03	XX
Provenzal Antique Brass	Otros acabados Other finishes

Ref.	A	B	C	D		
556. 96	96	112	18	34	25	75
556.128	128	142	19	34	25	75
557. 34	-	-	34	29	50	100

	Ref.
	556. 96.A
Porcelana flor Azul Porcelain blue flower	556.128.A
	557. 34.A

	Ref.
	556. 96.C
Porcelana Craquelé Porcelain craquelé	556.128.C
	557. 34.C

	Ref.
	556. 96.M
Porcelana flor Marrón Porcelain brown flower	556.128.M
	557. 34.M

	Ref.
	556. 96.V
Porcelana flor Verde Porcelain green flower	556.128.V
	557. 34.V



sc herrajes®



DIVERSE

07

07. Diverse



821 ZAMAK

Juego de 4 barras
Set of 4 bars

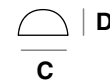
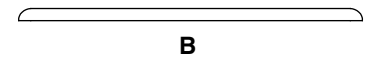

Acabados Finishes

04

 Cromo brillo
Bright chrome

Ref.

821.300

A

Adhesivo

B

300

C

12

D

6



32



96

22 ZAMAK

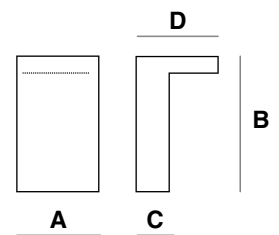

Acabados Finishes

04



Cromo brillo
Bright chrome

30

Cromo mate
Matt Chrome

58

Niquel satinado
Brush Satin Nickel

	Ref.	A	B	C	D		
Cromo brillo Bright chrome	22. 70	90	70	15	55	25	75
	22.100	50	100	15	55	25	100
	22.150	50	150	20	55	20	60
Cromo mate Matt Chrome	22.150	50	150	20	55	25	75
	22. 70	90	70	15	55	25	75
	22.100	50	100	15	55	25	100
Niquel satinado Brush Satin Nickel	22.150	50	150	20	55	25	75

07. Diverse



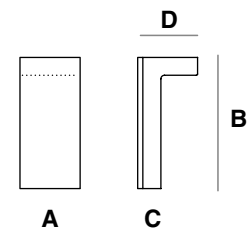

21 ZAMAK



Acabados Finishes

04

 Cromo brillo
Bright chrome

Ref.	A	B	C	D		
21.100	50	100	17	40	25	100
21.150	50	150	17	50	25	75
21.200	50	200	17	50	25	50
21.260	50	260	17	50	12	36
21.300	50	300	19	50	10	30

MT 824 ZAMAK

Juego de 2 tiradores VIDRIO: 6 - 8 - 10 mm.
Set of 2 handles GLASS: 6 - 8 - 10 mm.



MT 824 POMO ZAMAK

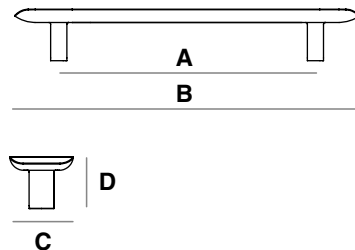

Acabados Finishes

04

 Cromo brillo
Bright chrome

Ref.

MT.824.200

MT.824.200L

MT.824.200R



A

B

C

D





Ref.	A	B	C	D		
MT.824.200	200	250	30	36	24	-
MT.824.200L	200	250	30	36	24	-
MT.824.200R	200	250	30	36	24	-

07. Diverse

MT 816 ZAMAK

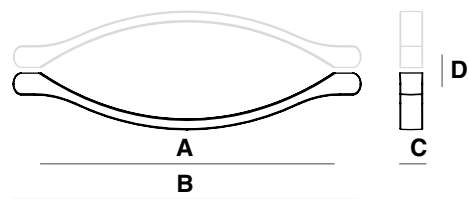
Juego de 2 tiradores VIDRIO: 6 - 8 - 10 mm.
Set of 2 handles GLASS: 6 - 8 - 10 mm.



Ref.	A	B	C	D		
MT816.192	192	214	10	26	12	-
MT816.192N	192	214	10	26	12	-

MT 801 ZAMAK

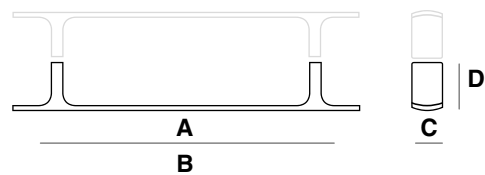

Acabados Finishes

04





Cromo brillo
Bright chrome

08



Lacado negro
Black

Ref.	A	B	C	D		
MT801.192	192	256	16	29	12	-
MT801.192N	192	256	16	29	12	-

MT 770 ALUMINIO ZAMAK

Juego de 2 tiradores VIDRIO: 6 - 8 - 10 mm. Set of 2 handles GLASS: 6 - 8 - 10 mm.



Acabados Finishes

04



08

Cromo brillo
Bright chrome

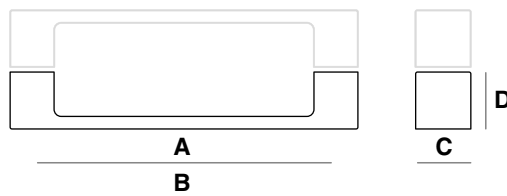
Lacado negro
Black



Ref.

Ref.	A	B	C	D		
MT770.160	160	185	25	28	18	-
MT770.160N	160	185	25	28	18	-
MT770.256	256	281	25	28	12	-

MT 770 ADHESIVO ALUMINIO ZAMAK



Acabados Finishes

04

Cromo brillo
Bright chrome

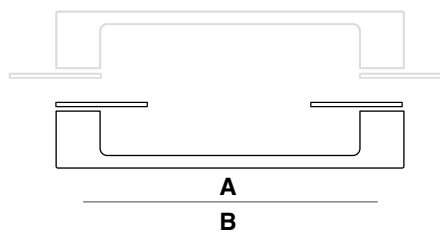

Ref.

Ref.	A	B	C	D		
MT770.256A	Adhesivo	281	25	28	12	-

07. Diverse

MT 709 ALUMINIO ZAMAK

Juego de 2 tiradores VIDRIO: 6 - 8 - 10 mm.
Set of 2 handles GLASS: 6 - 8 - 10 mm.

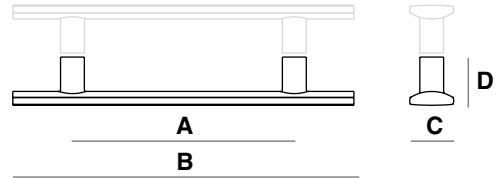
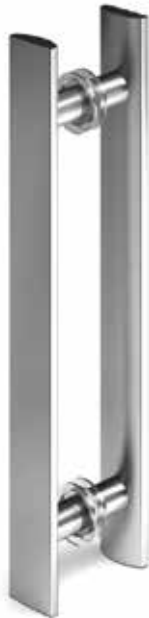

Ref.
MT709.250

A	B	C	D		
250	320	25	28	12	-

MT 709 POMO ALUMINIO ZAMAK



Acabados Finishes

04



Cromo brillo
Bright chrome

08



Lacado negro
Black

Ref.
MT709.128P
MT709.128PN
MT709.250P

A	B	C	D		
128	198	25	28	25	-
128	198	25	28	25	-
250	320	25	28	30	-

MT 771 ZAMAK

Juego de 2 pomos VIDRIO: 6 - 8 - 10 mm.

Set of 2 knobs GLASS: 6 - 8 - 10 mm.

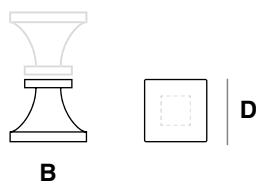

Ref.	A	B	C	D		
MT771.40	-	40	-	38	20	60

MT 772 LATÓN

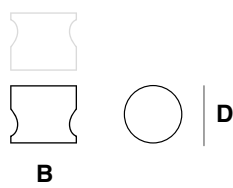

Acabados Finishes

04

Cromo brillo
Bright chrome

08

Lacado negro
Black

Ref.	A	B	C	D		
MT772. 36	-	36	-	26	20	-

SÍMBOLOS Y SEÑALES

KEY SYMBOLS

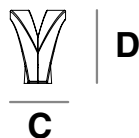
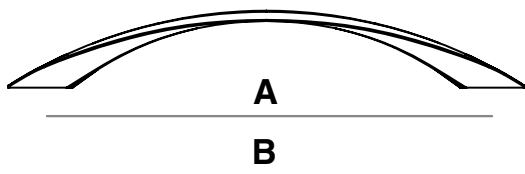

- A** distancia entre taladros
distance between drill holes
- B** largo total
total length
- C** ancho
width
- D** alto
height

834.160.04 número de modelo
model number

834.160.04 distancia entre taladros / largo total en modelos sin taladros
distance between drill holes / total length in models with no drill holes

834.160.04 referencia del acabado
reference of finishes



unidades por caja
units for each box



unidades por embalaje de cajas
units for pack of boxes

ACABADOS PERFIL ALUMINIO Y GOLA / ALU AND GOLA PROFILE FINISHES

Acabados / Finished

06	07	08	09	31	57	61	63	xx
Lacado blanco White	Anodizado negro Anodized Black	Lacado negro Black	Anodizado negro satinado Anodized Brushed Black	Anodizado plata Anodized silver	Efecto inox Inox effect	Grafito satinado graphite anodized	Lacado gris Grey	Otros acabados Other finishes















ACABADOS TIRADORES - DIVERSE / HANDLES - DIVERSE FINISHES

Acabados / Finished

03	04	05	06	08	10	12	30	58	60	xx
Provenzal Antique Brass	Cromo brillo Bright chrome	Plata vieja Antique silver	Lacado blanco White	Lacado negro Black	Lacado gris Grey	Lacado arena Sand	Cromo mate Matt Chrome	Niquel satinado Brush Satin Nickel	Titanio Titanium	Otros acabados Other finishes

Índice Perfiles Aluminio Alu profile

INDEX

	Ref.	Pag.	Acabados / Finished									
			06	07	08	09	31	57	61	63	xx	
	848	8				●				●		
	848N	8				●				●		
	849	9	○					●	●	●		○
	771	10				●	●	●				
	772	11				●		●	●			
	769	12						●				
	770	13						●				
	773	14			●		●	●				
	774	15			●		●	●				
	765	16		●				●				
	768.19	17	○			●	●	●	●			
	768.21	18	○			●	●	●	●			
	768.19UP	19	○			●	●	●	●			
	768.21UP	19	○			●	●	●	●			
	761 762	20					●					

Acabados / Finished

06	07	08	09	31	57	61	63	xx
○ Lacado blanco White	● Anodizado negro Anodized Black	● Lacado negro Black	● Anodizado negro satinado Anodized Brushed Black	● Anodizado plata Anodized silver	● Efecto inox Inox effect	● Grafito satinado graphite anodized	● Lacado gris Grey	○ Otros acabados Other finishes

Índice Perfiles Gola Gola profiles

INDEX

	Ref.	Pag.	Acabados / Finished								
			06	07	08	09	31	57	61	63	xx
	757	24	○		●		●			●	
	757 ACCESORIOS	25	○		●		●			●	
	750	26	○					●			
	751	26	○					●			
	753	27	○					●			
	754	27	○					●			
	752.16 752.19	28	○		●			●			●
	755	29	○		●			●			●
	756	29	○		●			●			●

Acabados / Finished

06	07	08	09	31	57	61	63	xx
○ Lacado blanco White	● Anodizado negro Anodized Black	● Lacado negro Black	● Anodizado negro satinado Anodized Brushed Black	● Anodizado plata Anodized silver	● Efecto inox Inox effect	● Grafito satinado graphite anodized	● Lacado gris Grey	○ Otros acabados Other finishes

Índice Tiradores Handles

INDEX















	Ref.	Pag.	Acabados / Finished											
			03	04	05	06	08	10	12	30	58	60	xx	
	901	32		●										●
	902	33		●										●
	903	34		●										●
	904	35		●										●
	905	36		●										●
	850	44 45	●	●	●	○	●					●	●	●
	843	46	●	●	●		●					●		
	844	48		●	●		●					●		
	845	49		●								●		
	839	50		●			●					●		
	842	52		●								●		
	837	53		●								●		
	836	54		●								●		
	835	55		●		○	●	●	●			●	●	
	834	56		●								●		
	832	57		●								●		

Acabados / Finished

03	04	05	06	08	10	12	30	58	60	xx
● Provenzal Antique Brass	● Cromo brillo Bright chrome	● Plata vieja Antique silver	○ Lacado blanco White	● Lacado negro Black	● Lacado gris Grey	● Lacado arena Sand	● Cromo mate Matt Chrome	● Níquel satinado Brush Satin Nickel	● Titanio Titanium	● Otros acabados Other finishes

Índice Tiradores Handles

INDEX

	Ref.	Pag.	Acabados / Finished											
			03	04	05	06	08	10	12	30	58	60	xx	
	830	58		●								●		
	829	59		●	●							●		
	824	60		●				●				●		
	828	61		●				●				●		
	825	62		●		○		●	●	●		●	●	
	818	64		●				●				●		
	816	66	●	●	●	○		●	●	●		●	●	●
	815	67		●								●	●	
	814	68		●								●		
	378	70		●								●	●	●
	373	72		●								●	●	
	377	73		●								●	●	
	368	74		●								●	●	○
	365	75		●								●	●	
	370	76		●								●	●	
	305	77		●								●	●	

Acabados / Finished

03	04	05	06	08	10	12	30	58	60	xx
●	●	●	○	●	●	●	●	●	●	○
Provenzal Antique Brass	Cromo brillo Bright chrome	Plata vieja Antique silver	Lacado blanco White	Lacado negro Black	Lacado gris Grey	Lacado arena Sand	Cromo mate Matt Chrome	Níquel satinado Brush Satin Nickel	Titanio Titanium	Otros acabados Other finishes

Índice Tiradores Handles

INDEX

















	Ref.	Pag.	Acabados / Finished											
			03	04	05	06	08	10	12	30	58	60	xx	
	813	78		●							●	●		
	327	78												●
	808	79												●
	535	79												●
	374	80		●							●	●		
	375	80		●							●	●		
	367	80		●							●	●		
	240	81		●							●	●		
	807	81		●							●	●		
	576	81		●							●	●		
	704	82		●										●
	702	82		●										
	701	82		●										●
	392	83					○	●					●	●
	389	84												●
	385	85												●

Acabados / Finished

03	04	05	06	08	10	12	30	58	60	xx
● Provenzal Antique Brass	● Cromo brillo Bright chrome	● Plata vieja Antique silver	○ Lacado blanco White	● Lacado negro Black	● Lacado gris Grey	● Lacado arena Sand	● Cromo mate Matt Chrome	● Níquel satinado Brush Satin Nickel	● Titanio Titanium	● Otros acabados Other finishes

Índice Tiradores Handles

INDEX













	Ref.	Pag.	Acabados / Finished											
			03	04	05	06	08	10	12	30	58	60	xx	
	841	88		●				●				●		
	831	89		●				●			●	●		
	827	90		●										●
	826	91		●										●
	819	92		●							●		●	●
	820	92		●							●			●
	582	93		●								●		
	851	96	●		●									●
	852	98	●		●									●
	846	100	●		●									●
	348	101	●		●									●
	349	101	●		●									●
	847	102	●	●	●	○	●					●		●
	347	104	●		●									●
	345	104	●		●									●
	556	105	●											●
	557	105	●											●

Acabados / Finished

03	04	05	06	08	10	12	30	58	60	xx
●	●	●	○	●	●	○	●	●	●	●
Provenzal Antique Brass	Cromo brillo Bright chrome	Plata vieja Antique silver	Lacado blanco White	Lacado negro Black	Lacado gris Grey	Lacado arena Sand	Cromo mate Matt Chrome	Niquel satinado Brush Satin Nickel	Titanio Titanium	Otros acabados Other finishes

Índice Diverse

INDEX

	Ref.	Pag.	Acabados / Finished											
			03	04	05	06	08	10	12	30	58	60	xx	
	821	108		●										
	22	109		●							●	●		
	21	110		●										
	MT824	111		●										
	MT824 POMO	111		●										
	MT816	112		●				●						
	MT801	112		●				●						
	MT770	113		●				●						
	MT770 ADHESIVO	113		●										
	MT709	114		●				●						
	MT709 POMO	114		●				●						
	MT771	115		●				●						
	MT772	115		●				●						

Acabados / Finished

03	04	05	06	08	10	12	30	58	60	xx
● Provenzal Antique Brass	● Cromo brillo Bright chrome	● Plata vieja Antique silver	○ Lacado blanco White	● Lacado negro Black	● Lacado gris Grey	● Lacado arena Sand	● Cromo mate Matt Chrome	● Níquel satinado Brush Satin Nickel	● Titanio Titanium	● Otros acabados Other finishes

PREGUNTAS FRECUENTES

VENTAS

CANTIDAD MÍNIMA Y EMPAQUETADO

La cantidad mínima por pedido es 1 caja completa.

Cada caja contiene entre 10/50 unidades como viene especificado en la información de cada modelo.

Estas cantidades podrían ser modificadas sin previo aviso, según las necesidades de SC.

ENVÍOS

Los plazos de entrega dependen de la distancia de destino y la red de organizada por las distintas compañías de transporte.

Los plazos de entrega estandar son los siguientes:

- Península: 24h - 48h.

- Islas / Europa Occidental: 2 - 5 días.

Para bulto de más de 2,4m de largo, el transporte queda a cargo del cliente.

PRODUCTO

REGISTRO E IDENTIFICACIÓN

Todos los diseños de SC están registrados por Instituciones Europeas.

El producto original de SC puede ser identificado a través de una marca con el logotipo y la referencia de cada modelo ubicada en la parte no visible de cada tirador.

LIMPIEZA Y MANTENIMIENTO

La limpieza de los tiradores debe realizarse con una gamuza seca de microfibra.

Bajo ninguna circunstancia debe utilizarse ningún tipo de limpiador de metales, productos de limpieza en aerosol o soluciones abrasivas a base de disolvente en nuestros productos, ya que pueden eliminar las lacas de protección sobre el metal. Si este tipo de productos es utilizado, el tirador puede dañarse.

EMPRESA

MARCA Y LOGOTIPO

SC HERRAJES y su logotipo son una marca registrada. Su uso por terceros está prohibido salvo consentimiento expreso de SC.

sc herrajes® 

SPECIAL PROJECTS

SC Herrajes tiene la capacidad de producir y asesorar en la creación de modelos de tiradores especiales o exclusivos. Estos proyectos requieren plazos de entrega y cantidades especiales para su aprobación. Si usted está interesado en desarrollar un producto especial con nosotros, póngase en contacto con nuestro departamento de producción.

CERTIFICADOS DE CALIDAD

SC Herrajes está certificada por AENOR en la norma de calidad ISO 9001 desde 2004, para nuestros productos y procesos de gestión.

Además, todos nuestros modelos se someten a los controles de calidad más estrictos, superando las 72 horas en los test de niebla salina contra la corrosión.



FREQUENTLY ASKED QUESTIONS

SALES

MINIMUM QUANTITY & PACKAGING

The minimum quantity per order is 1 complete box.

The quantities per box go between 10/50 units and are specified in the information of each model.

These quantities can be modified according to the needs of SC.

SHIPMENTS

Delivery times depend on distance and the net organized by the different transport companies.

Standard delivery times go as follow:

- Western Europe: 2 – 5 Days
- Rest of the world: 7 – 30 Days

For parcels longer than 2,4m, transport will be responsibility of the client.

PRODUCT

REGISTRY & IDENTIFICATION

All designs of SC Herrajes are registered by European Institutions.

Original models of SC can be identified through a mark with the logo and reference of each model placed in the hidden part of each handle.

CLEANING & MAINTENANCE

Cleaning of the handles must be done with a dry lint free cloth.

Under no circumstances should costumers use any form of metal cleaner, aerosol spray cleaner or solvent based abrasive cleaning solutions on our product as these can remove protective laquers. If such cleaning agents are used, products can become damaged.

COMPANY

LOGO & BRAND

SC HERRAJES and its logo are a registered brand.

Its use by third parties is not permitted unless direct consent by SC.



SPECIAL PROJECTS

SC Herrajes has the ability to produce and advise in the creation process of special or exclusive handle models. These projects require special quantities and delivery times to start. If you are interested in developing an special product with us, contact our production department

QUALITY CERTIFICATIONS

SC Herrajes has the AENOR certificate for the quality norm ISO 9001 since 2004, for our products and managing processes.

Also, all of our models overpass the most strict quality controls, reaching up to 72 hours in the salt spray tests against rust and corrosion.



SC Herrajes around the world

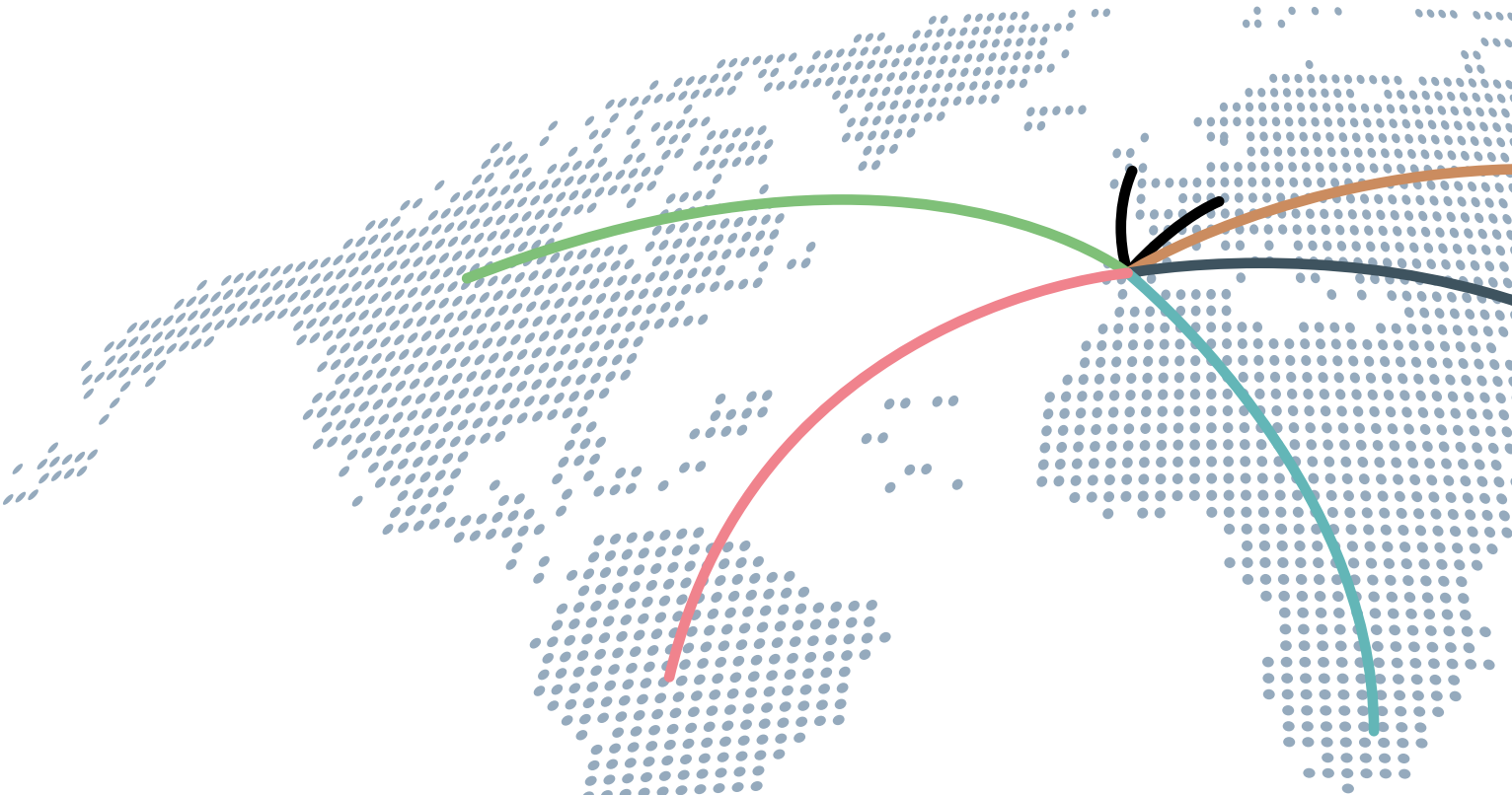

sc herrajes®

For any further details concerning agents or distributors please contact: export@sc-herrajes.com



MINIMUM QUANTITY & PACKAGING

The minimum quantity per order is 1 complete box. The quantities per box go between 10/50 units and are specified in the information of each model. These quantities can be modified according to the needs of SC.

SHIPMENTS

Delivery times depend on distance and the net organized by the different transport companies.

Standard delivery times go as follow:

- Western Europe: 2 – 5 Days
- Rest of the world: 7 – 30 Days

For parcels longer than 2,4m, transport will be responsibility of the client.

PRODUCT

REGISTRY & IDENTIFICATION

All designs of SC Herrajes are registered by European Institutions.

Original models of SC can be identified through a mark with the logo and reference of each model placed in the hidden part of each handle.

CLEANING & MAINTENANCE

Cleaning of the handles must be done with a dry lint free cloth.

Under no circumstances should costumers use any form of metal cleaner, aerosol spray cleaner or solvent based abrasive cleaning solutions on our product as these can remove protective laquers. If such cleaning agents are used, products can become damaged.

NOTAS

NOTES



sc herrajes®

Avenida de las Naciones, 31
45200 ILLESCAS, Toledo, SPAIN

Tel. +34 925 51 24 24

Fax +34 925 54 08 74

info@sc-herrajes.com

www.sc-herrajes.com

