

2020

CATÁLOGO GENERAL
GENERAL CATALOGUE

PAVIMENTOS Y REVESTIMIENTOS
FLOOR AND WALL SURFACES

MDi



ÍNDICE / CONTENTS

INTRODUCCIÓN / INTRODUCTION	04
PALETA DE COLOR / COLOUR PALETTE	10
GALERÍA DE IMÁGENES / PHOTO GALLERY	14
BÚSQUEDAS DE PRODUCTO / PRODUCT SEARCHINGS	110
BÚSQUEDA POR FORMATO / SEARCHING BY FORMAT	112
BÚSQUEDA POR COLOR / SEARCHING BY COLOUR	114
BÚSQUEDA POR ACABADO / SEARCHING BY FINISHING	116
SIMBOLOGÍA / SYMBOLS	118
POLÍTICA MEDIOAMBIENTAL / ENVIRONMENTAL POLICY	120



ÍNDICE / CONTENTS

PRODUCTO DISPONIBLE / AVAILABLE PRODUCT	132		
Alea	134	Lena	174
Ananda	136	Masai	176
Antal	138	Meteora	178
Arizona	140	Moon	182
Astral	142	Oxide	186
Azalai	144	Pacific	188
Bosco	146	Petra	192
Fibre	148	Rift	196
Fluorite	150	Senda	198
Fusion	152	Silk	200
Geo	154	Soho	204
Ground	156	Storm	206
Ice	158	Syros	210
Iseo	162	The New Blacks	212
Jasper	166	Touché	214
Joy	168	Umbra	220
Larsen	170	Vint	224
CERAMIC PORCELAIN TILES	228		
COMPLEMENTOS / COMPLEMENTS	230		
ENMALLADOS / MESH-MOUNTED TILES	232		
RODAPIÉS Y PELDAÑOS / SKIRTINGS AND STEPS	234		
INFORMACIÓN TÉCNICA / TECHNICAL INFORMATION	238		
PRODUCTO ANTIDESLIZANTE (Clase 3 - R12 - A+B+C) / NON-SLIP PRODUCT (Class 3 - R12 - A+B+C)	240		
LIMPIEZA Y MANTENIMIENTO / CLEANING AND MAINTENANCE	244		
CARACTERÍSTICAS TÉCNICAS MDI PARA PAVIMENTOS Y REVESTIMIENTOS / MDI TECHNICAL CHARACTERISTICS FOR FLOOR AND WALL SURFACES	246		
CONSEJOS DE COLOCACIÓN / TILE-LAYING TIPS	248		



 **inalco**
looking forward

Somos una compañía dedicada a suministrar servicios y superficies **MDI** de gran formato y fino espesor al sector de la construcción, la arquitectura y el interiorismo.

La unión de la últimas tecnologías **H₂O⁺FD**, el mejor saber hacer humano, el diseño y la innovación en todos los procesos y productos de la empresa, nos permite crear productos únicos y extraordinarios, acordes con las últimas tendencias en decoración.

We are a specialist supplier of services and big formats and slim thickness **MDI** surfaces for the construction industry and architecture and interior design sectors.

Combining **H₂O⁺FD** cutting-edge technology, the best know-how and continuous innovation in production processes and products allow us to create extraordinary unique products according to the latest trends in decoration.



INNOVACIÓN Y TECNOLOGÍA H₂O⁺FD

Fruto de la continua investigación en I + D + I, INALCO es la primera compañía a nivel mundial en aplicar en todos sus productos la tecnología H₂O⁺FD, en la que todos los procesos productivos son digitales y en la que no existe ninguna emisión contaminante, reafirmando su compromiso y responsabilidad con el medio ambiente y la sociedad.

INNOVATION & H₂O⁺FD TECHNOLOGY

Through ongoing R&D and innovation, INALCO is the first company worldwide to have applied H₂O⁺FD technology to all its products. All the production processes involved in this technology are fully digital, with no pollutant emissions, thus reaffirming INALCO's environmental and social commitment.



MDI

Minerals, Design, Innovation

¿QUÉ ES MDI?

MDI está diseñado con minerales de altísima pureza que, fundidos a alta temperatura en un proceso productivo revolucionario, aportan cualidades técnicas, superficiales y estéticas extraordinarias.

La tecnología *Full Digital* aplicada en todo su proceso productivo permite un control total del diseño, una extraordinaria definición y una suavidad inigualable. En cada creación, interior y exterior se integran con un diseño 360° que favorece la continuidad estética entre cuerpo y superficie.

Texturas, colores y acabados creados para estimular tus sentidos. **MDI** despierta tu creatividad marcando la diferencia entre un producto que gusta y uno que enamora.

WHAT MDI IS?

MDI is made of high-purity minerals, fused at a high temperature in a ground-breaking manufacturing process, leading to outstanding technical, surface and visual properties.

By using *Full Digital* technology throughout the whole production process, total control over the design is guaranteed, combined with an amazing definition and an unparalleled smooth feel. Through the use of 360° design, each new creation's inner core and outer surface are fully integrated to ensure visual continuity between the two.

Textures, colours and finishes conceived to stimulate the senses. **MDI** fuels your creativity, making the difference between a product you like and one you are passionately in love with.



PALETA DE COLOR
COLOUR PALETTE

<p>ICE Super Blanco Natural / Natural</p>	<p>ICE Super Blanco Pulido Brillo / High-gloss Polished</p>	<p>SILK Blanco Natural / Natural</p>	<p>SILK Blanco Abujardado / Bush-hammered</p>	<p>FIBRE Blanco Yuta</p>
<p>FIBRE Blanco Mohair</p>	<p>FIBRE Blanco Rafia</p>	<p>SYROS Super Blanco-Gris Natural / Natural</p>	<p>SYROS Super Blanco-Gris Pulido Mate / Matt Polished</p>	<p>TOUCHÉ Super Blanco-Gris Natural / Natural</p>
<p>TOUCHÉ Super Blanco-Gris Abujardado / Bush-hammered</p>	<p>TOUCHÉ Super Blanco-Gris Pulido Brillo / High-gloss Polished</p>	<p>LARSEN Super Blanco-Gris Natural / Natural</p>	<p>LARSEN Super Blanco-Gris Pulido Brillo / High-gloss Polished</p>	<p>ANANDA Super Blanco-Crema Arenado</p>
<p>FLUORITE Blanco Plus Natural / Natural</p>	<p>MASAI Blanco Plus Abujardado / Bush-hammered</p>	<p>PACIFIC Blanco Plus Natural / Natural</p>	<p>PACIFIC Blanco Plus Abujardado / Bush-hammered</p>	<p>RIFT Blanco Natural / Natural</p>
<p>SOHO Blanco Abujardado / Bush-hammered</p>	<p>PETRA Crema Natural / Natural</p>	<p>PETRA Crema Abujardado / Bush-hammered</p>	<p>GEO Crema Abujardado / Bush-hammered</p>	<p>ANTAL Crema Abujardado / Bush-hammered</p>
<p>BOSCO Crema Natural / Natural</p>	<p>BOSCO Camel Natural / Natural</p>	<p>SILK Camel Natural / Natural</p>	<p>SILK Camel Abujardado / Bush-hammered</p>	<p>SILK Visón Natural / Natural</p>
<p>SILK Visón Abujardado / Bush-hammered</p>	<p>FIBRE Visón Yuta</p>	<p>FIBRE Visón Mohair</p>	<p>FIBRE Visón Rafia</p>	<p>JASPER Moka Abujardado / Bush-hammered</p>
<p>JASPER Deco Moka Abujardado / Bush-hammered</p>	<p>ARIZONA Fresno Natural / Natural</p>	<p>OXIDE Corten Natural / Natural</p>	<p>UMBRA Marrón Abujardado / Bush-hammered</p>	<p>FUSION Iris Natural / Natural</p>

<p>ALEA Piedra Natural / Natural</p>	<p>JOY Piedra Natural / Natural</p>	<p>FLUORITE Piedra Natural / Natural</p>	<p>GROUND Piedra Natural / Natural</p>	<p>MASAI Piedra Abujardado / Bush-hammered</p>
<p>ISEO Gris Abujardado / Bush-hammered</p>	<p>METEORA Gris Abujardado / Bush-hammered</p>	<p>VINT Gris Natural / Natural</p>	<p>VINT Gris Abujardado / Bush-hammered</p>	<p>VINT Deco Gris Abujardado / Bush-hammered</p>
<p>GEO Gris Abujardado / Bush-hammered</p>	<p>STORM Gris Natural / Natural</p>	<p>STORM Gris Pulido Brillo / High-gloss Polished</p>	<p>ASTRAL Gris Natural / Natural</p>	<p>MOON Gris Abujardado / Bush-hammered</p>
<p>SENDA Gris Natural / Natural</p>	<p>PACIFIC Gris Natural / Natural</p>	<p>PACIFIC Gris Abujardado / Bush-hammered</p>	<p>SILK Gris Natural / Natural</p>	<p>SILK Gris Abujardado / Bush-hammered</p>
<p>LENA Gris Abujardado / Bush-hammered</p>	<p>FLUORITE Negro Natural / Natural</p>	<p>STORM Negro Natural / Natural</p>	<p>STORM Negro Pulido Brillo / High-gloss Polished</p>	<p>AZALAI Negro Natural / Natural</p>
<p>THE NEW BLACKS Amaranto Natural / Natural</p>	<p>THE NEW BLACKS Castagna Natural / Natural</p>	<p>THE NEW BLACKS Muschio Natural / Natural</p>	<p>THE NEW BLACKS Prugna Natural / Natural</p>	<p>SILK Negro Natural / Natural</p>
<p>SILK Negro Abujardado / Bush-hammered</p>	<p>FIBRE Negro Yuta</p>	<p>FIBRE Negro Mohair</p>	<p>FIBRE Negro Rafia</p>	



GALERÍA DE IMÁGENES
PHOTO GALLERY





ALEA
Piedra Natural / Natural



ANTAL
Crema Abujardado / Bush-hammered



ARIZONA
Fresno Natural / Natural



ASTRAL
Gris Natural / Natural



SENDA
Gris Natural / Natural

ASTRAL
Gris Natural / Natural



ASTRAL
Gris Natural / Natural



AZALAI
Negro Natural / Natural



AZALAI
Negro Natural / Natural



BOSCO
Camel Natural / Natural



FIBRE
Rafia Negro



FIBRE
Mohair Visón



FLUORITE
Negro Natural / Natural



FUSION
Iris Natural / Natural



FUSION
Iris Natural / Natural



GEO
Gris Abujardado / Bush-hammered

SILK
Camel Natural / Natural



GEO
Crema Abujardado / Bush-hammered



GEO
Crema Abujardado / Bush-hammered



GROUND
Piedra Natural / Natural



ICE
Super Blanco Natural / Natural



ISEO
Gris Abujardado / Bush-hammered



ISEO
Gris Abujardado / Bush-hammered



ISEO
Gris Abujardado / Bush-hammered



JASPER
Deco Moka Abujardado / Bush-hammered

ALEA
Piedra Natural / Natural



JASPER
Moka Abujardado / Bush-hammered



JASPER
Moka Abujardado / Bush-hammered



JOY
Piedra Natural / Natural



LARSEN
Super Blanco-Gris Natural / Natural



LENA
Gris Abujardado / Bush-hammered



LENA
Gris Abujardado / Bush-hammered



MASAI
Piedra Abujardado / Bush-hammered



METEORA
Gris Abujardado / Bush-hammered



METEORA
Gris Abujardado / Bush-hammered



METEORA
Gris Abujardado / Bush-hammered



MOON
Gris Abujardado / Bush-hammered



MOON
Gris Abujardado / Bush-hammered



UMBRA
Marrón Abujardado / Bush-hammered



OXIDE
Corten Natural / Natural



OXIDE
Corten Natural / Natural





PETRA
Crema Natural / Natural



PETRA
Crema Natural / Natural



PETRA
Crema Natural / Natural



RIFT
Blanco Natural / Natural



RIFT
Blanco Natural / Natural



SENDA
Gris Natural / Natural



SENDA
Gris Natural / Natural



SENDA
Gris Natural / Natural



SILK
Gris Natural / Natural



SOHO
Blanco Abujardado / Bush-hammered



SOHO
Blanco Abujardado / Bush-hammered



STORM
Negro Natural / Natural



STORM
Gris Pulido Brillo / High-gloss Polished



STORM
Gris Pulido Brillo / High-gloss Polished



SYROS
Super Blanco-Gris Pulido Mate / Matt Polished



SYROS
Super Blanco-Gris Pulido Mate / Matt Polished



SYROS
Super Blanco-Gris Pulido Mate / Matt Polished



THE NEW BLACKS
Castagna Natural / Natural



THE NEW BLACKS
Muschio Natural / Natural



THE NEW BLACKS
Muschio Natural / Natural



TOUCHÉ
Super Blanco-Gris Natural / Natural



TOUCHÉ
Super Blanco-Gris Natural / Natural



TOUCHÉ
Super Blanco-Gris Pulido Brillo / High-gloss Polished



UMBRA
Marrón Non-slip



UMBRA
Marrón Abujardado / Bush-hammered



UMBRA
Marrón Abujardado / Bush-hammered



VINT
Deco Gris Abujardado / Bush-hammered
SILK
Negro Abujardado / Bush-hammered



VINT
Gris Natural / Natural



VINT
Gris Abujardado / Bush-hammered



BÚSQUEDAS DE PRODUCTO
PRODUCT SEARCHINGS



BÚSQUEDA POR FORMATO / SEARCHING BY FORMAT

	150 x 300 cm 59" x 118 1/8"	150 x 150 cm 59" x 59"	100 x 250 cm 39 3/8" x 98 3/8"	100 x 100 cm 39 3/8" x 39 3/8"	30 x 300 cm 11 3/4" x 118 1/8"
ALEA		✓	✓	✓	
ANANDA	✓	✓	✓	✓	
ANTAL		✓		✓	
ARIZONA					✓
ASTRAL	✓	✓	✓	✓	
AZALAI	✓	✓	✓	✓	
BOSCO					
FIBRE			✓		
FLUORITE			✓	✓	
FUSION			✓		
GEO	✓		✓	✓	
GROUND			✓	✓	
ICE	✓	✓	✓	✓	
ISEO	✓	✓	✓	✓	
JASPER		✓	✓	✓	
JOY				✓	
LARSEN	✓	✓	✓	✓	
LENA	✓	✓			
MASAI		✓	✓	✓	
METEORA	✓	✓	✓	✓	
MOON		✓	✓	✓	
OXIDE	✓		✓		
PACIFIC	✓	✓	✓	✓	
PETRA	✓		✓	✓	
RIFT			✓	✓	
SENDA	✓	✓	✓	✓	
SILK	✓	✓	✓	✓	
SOHO			✓	✓	
STORM	✓	✓	✓	✓	
SYROS	✓	✓	✓	✓	
THE NEW BLACKS			✓		
TOUCHÉ	✓	✓	✓	✓	
UMBRA	✓	✓	✓	✓	
VINT	✓	✓	✓	✓	



BÚSQUEDA POR FORMATO / SEARCHING BY FORMAT

	30 x 150 cm 11 3/4" x 59"	HEX. 25 x 19,5 cm HEX. 9 3/4" x 7 3/4"	20 x 30 cm 7 7/8" x 11 3/4"	20 x 20 cm 7 7/8" x 7 7/8"	10 x 20 cm 3 7/8" x 7 7/8"
ALEA					
ANANDA					
ANTAL					
ARIZONA	✓				
ASTRAL					
AZALAI					
BOSCO	✓				
FIBRE					
FLUORITE					
FUSION					
GEO					
GROUND					
ICE					
ISEO				✓	✓
JASPER					
JOY					
LARSEN					
LENA					
MASAI					
METEORA					
MOON			✓	✓	✓
OXIDE					
PACIFIC					
PETRA					
RIFT					
SENDA					
SILK				✓	✓
SOHO					
STORM					
SYROS					
THE NEW BLACKS				✓	✓
TOUCHÉ					
UMBRA		✓	✓	✓	✓
VINT		✓		✓	✓



	Super Blanco	Super Blanco Gris	Super Blanco Crema	Blanco Plus	Blanco	Crema	Piedra	Camel	Visión	Moka	Deco Moka
ALEA											
ANANDA											
ANTAL											
ARIZONA											
ASTRAL											
AZALAI											
BOSCO											
FBRE											
FLUORITE											
FUSION											
GEO											
GROUND											
ICE											
ISEO											
JASPER											
JOY											
LARSEN											
LENA											
MASAI											
METEORA											
MOON											
OXIDE											
PACIFIC											
PETRA											
RIFT											
SENDA											
SILK											
SOHO											
STORM											
SYROS											
THE NEW BLACKS											
TOUCHÉ											
UMBRA											
VINT											

	Fresno	Marrón	Iris	Corten	Gris	Deco Gris	Amaranto	Castagna	Muschio	Frugna	Negro
ALEA											
ANANDA											
ANTAL											
ARIZONA											
ASTRAL											
AZALAI											
BOSCO											
FBRE											
FLUORITE											
FUSION											
GEO											
GROUND											
ICE											
ISEO											
JASPER											
JOY											
LARSEN											
LENA											
MASAI											
METEORA											
MOON											
OXIDE											
PACIFIC											
PETRA											
RIFT											
SENDA											
SILK											
SOHO											
STORM											
SYROS											
THE NEW BLACKS											
TOUCHÉ											
UMBRA											
VINT											



BÚSQUEDA POR ACABADO / SEARCHING BY FINISHING

	Natural Natural	Abujardado Brush-hammered	Arenado	Pulido Mate Matt Polished	Pulido Brillo High-gloss Polished	Yuta	Mohair	Rafia	Non-slip
ALEA	✓								
ANANDA			✓						
ANTAL		✓							
ARIZONA	✓								
ASTRAL	✓								
AZALAI	✓								
BOSCO	✓								
FIBRE						✓	✓	✓	
FLUORITE	✓								
FUSION	✓								
GEO		✓							
GROUND	✓								
ICE	✓				✓				
ISEO		✓							✓
JASPER		✓							✓
JOY	✓								
LARSEN	✓				✓				
LENA		✓							
MASAI		✓							✓
METEORA		✓							✓
MOON		✓							✓
OXIDE	✓								
PACIFIC	✓	✓							✓
PETRA	✓	✓							✓
RIFT	✓								
SENDA	✓								
SILK	✓	✓							
SOHO		✓							✓
STORM	✓				✓				
SYROS	✓			✓					
THE NEW BLACKS	✓								
TOUCHÉ	✓	✓			✓				
UMBRA		✓							✓
VINT	✓	✓							

SIMBOLOGÍA / SYMBOLS



Consultar datos de producto antideslizante de la serie
See details of non-slip products in the series
Consulter les données de produit antidérapant de la série
Bitte Produkten mit Trittsicherheit prüfen
Consultare i valori del prodotto antiscivolo
Консультировать данные противоскользящих продукт



Es necesario rejuntar
Must be grouted
Jointoiment nécessaire
Verfugen erforderlich
Occorre stuccare le fughe
Необходимо заполнение швов



Pieza enmallada.
Se puede cortar con tijeras
Mesh-mounted tiles.
Can be cut with scissors
Pièce sur filet.
Peut être coupé aux ciseaux
Auf Netz gezogene Fliesen.
Können mit der Schere auseinander geschnitten werden
Pezzo montato su rete.
Può essere tagliato con le forbici
Изделие на сетке.
Можно разрезать ножницами



Número de diseños del modelo por formato
Number of designs per size
Nombre de dessins du modèle par format
Verschiedene Designs des Modells je nach Format
Numero de disegni de modello per formato
Различные дизайны серии по форматам

SIMBOLOGÍA / SYMBOLS

Código QR: escanear y ver productos en la web
QR Code: scan and see products on website
QR Code: scannez pour voir nos produits
QR-Code: scannen und sehen Sie das Produkt auf der Website
Codice QR: scansione e vedere i prodotti nella web
Код КР : сканировать и проверить товары на сайте

Características generales y nombre de la serie
General characteristics and name of series
Caractéristiques générales et nom de la série
Allgemeine Eigenschaften und Name der Serie
Caratteristiche generali e nome della serie
Общие характеристики и название серии

Porción del acabado de la pieza
Close up of tile finish
Détail de la finition de la pièce
Ausschnitt von der Ausführung des Teils
Particolare della finitura del pezzo
Деталь отделки изделия

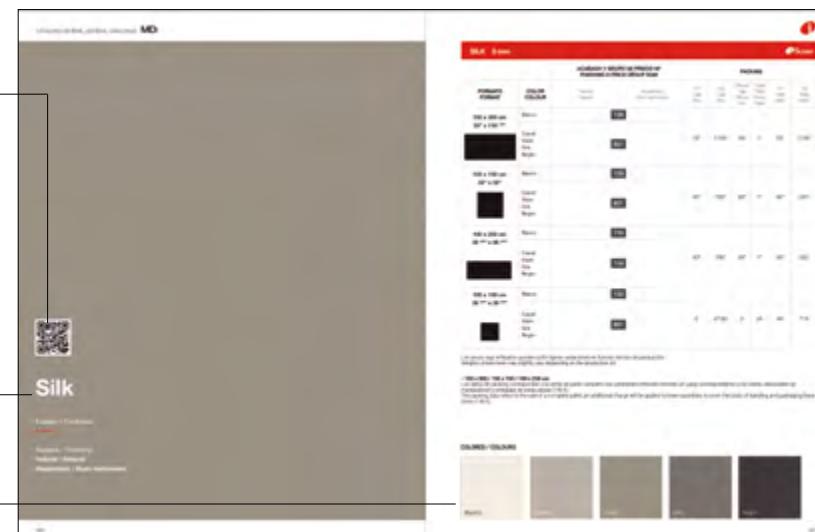

Formato
Format
Format
Format
Formato
Формат

Color
Colour
Couleur
Farben
Colore
цвет

Códigos de precio
Price codes
Codes de prix
Preiscodes
Codici di prezzi
Ценовые коды



Espesor
Thickness
Épaisseur
Dicke
Spessore
Толщина

Packing
Packaging
Emballage
Verpackung
Imballaggio
упаковка

Acabado de las piezas
Surface finish of the piece
Finition de la surface de la pièce
Oberfläche des Stückes
Finitura della superficie
Поверхность керамогранита

No olvide verificar productos y fecha de edición antes de cursar su pedido. Inalco se reserva el derecho de modificar total o parcialmente el contenido de este catálogo.

Remember to check products and publication date of catalogue before placing an order. Inalco reserves the right to modify the contents of this catalogue either fully or in part.

N'oubliez pas de vérifier les articles et la date d'édition du catalogue avant de passer votre commande. Inalco se réserve le droit de modifier totalement ou partiellement le contenu de ce catalogue.

Bitte prüfen Sie nochmals die Produkte und Ausgabedatum des Katalogs, bevor Sie Ihre Bestellung aufgeben. Inalco behält sich das Recht vor, den Inhalt dieses Katalogs ganz oder teilweise zu ändern.

Verificare i prodotti e la data di pubblicazione prima dell'inoltro dell'ordine. Inalco si riserva il diritto di modificare in toto o in parte il contenuto di questo catalogo.

Перед оформлением заказа не забудьте проверить товары и дату публикации. Inalco оставляет за собой право на полное или частичное изменение содержания данного каталога.

STORM 10,5 mm

Espesor tradicional
Traditional thickness
Épaisseur normale
Herkömmlicher Dicke
Spessore tradizionale
традиционной толщины

STORM 6 mm

SLIMM

Espesor ISLIMM
ISLIMM thickness
Épaisseur ISLIMM
ISLIMM Dicke
Spessore ISLIMM
ISLIMM толщины



POLÍTICA MEDIOAMBIENTAL
ENVIRONMENTAL POLICY

ecoinalco

ecoinalco

POLÍTICA MEDIOAMBIENTAL / ENVIRONMENTAL POLICY

ECOINALCO, UN COMPROMISO RECONOCIDO PÚBLICAMENTE

Ecolnalco es el compromiso público de INALCO con el Medio Ambiente y la sociedad. Comprende la totalidad de los recursos humanos y tecnológicos destinados a prevenir el impacto de la actividad, así como la continua revisión de los procesos e inversiones necesarios para procurar un desarrollo sostenible y coherente con nuestros principios.

En INALCO somos conscientes de la importancia que tiene la contribución de todos en el desarrollo de prácticas responsables que respeten el Medio Ambiente y permitan que la sociedad avance hacia un mundo mejor.

Como empresa responsable que crece desde una perspectiva sostenible, INALCO ha considerado prioritario el control medioambiental de su actividad y ha proporcionado todos los medios técnicos, humanos y económicos a su alcance para prevenir el impacto ambiental que pueda generar su actividad y garantizar la seguridad de los trabajadores frente a los riesgos derivados de su trabajo.

ECOINALCO, A PUBLICLY ACKNOWLEDGED COMMITMENT

Ecolnalco is INALCO's public commitment to the environment and to society. It encompasses all the human and technological resources directed at preventing possible negative impacts caused by the company's activities, ongoing controls of manufacturing processes, and the necessary investment to ensure sustainable development in keeping with the firm's principles.

INALCO is aware of how important it is for everyone to contribute toward developing responsible, environmentally friendly practices that allow society to move forward on the road to a better world.

In its capacity as a socially responsible firm that follows a sustainable growth model, priority is given to environmental controls of INALCO's activities, investing all the technical, human and financial resources at its disposal in preventing the possible negative impacts of its activities while also guaranteeing the safety of its workers by avoiding occupational hazards.

POLÍTICA MEDIOAMBIENTAL / ENVIRONMENTAL POLICY

H₂O^{FD}

**MÁXIMA DEFINICIÓN – REDUCCIÓN DE RESIDUOS –
TINTAS Y ESMALTES CON BASE AGUA SIN EMISIONES A LA ATMÓSFERA**

**MAXIMUM RESOLUTION – REDUCTION OF WASTE –
WATER-BASED INKS AND GLAZES WITH NO ATMOSPHERIC EMISSIONS**

INALCO es la primera empresa a nivel mundial en implantar H₂O^{FD}.

Esta innovadora tecnología con tintas base agua permite obtener colecciones con una definición extraordinaria, además de ser ecológicas y sostenibles con el medio ambiente y la sociedad.

Gracias a H₂O^{FD}, MDI es el material más ecológico del mercado: La reducción de un 70% en el consumo de agua, la disminución de más del 90% de emisiones a la atmósfera y el reciclaje y la reutilización de los materiales, refuerzan el compromiso de INALCO con el medio ambiente.

INALCO is the first company in the world to have introduced H₂O^{FD} technology.

This innovative water-based inks technology allows for the creation of collections with an outstanding resolution, as well as being sustainable and environmentally friendly.

Thanks to the use of H₂O^{FD}, MDI is the eco-friendliest product on the market. 70% savings on water consumption, an over 90% reduction in atmospheric emissions, and the recycling and re-use of materials further reinforce INALCO's commitment to caring for the environment.

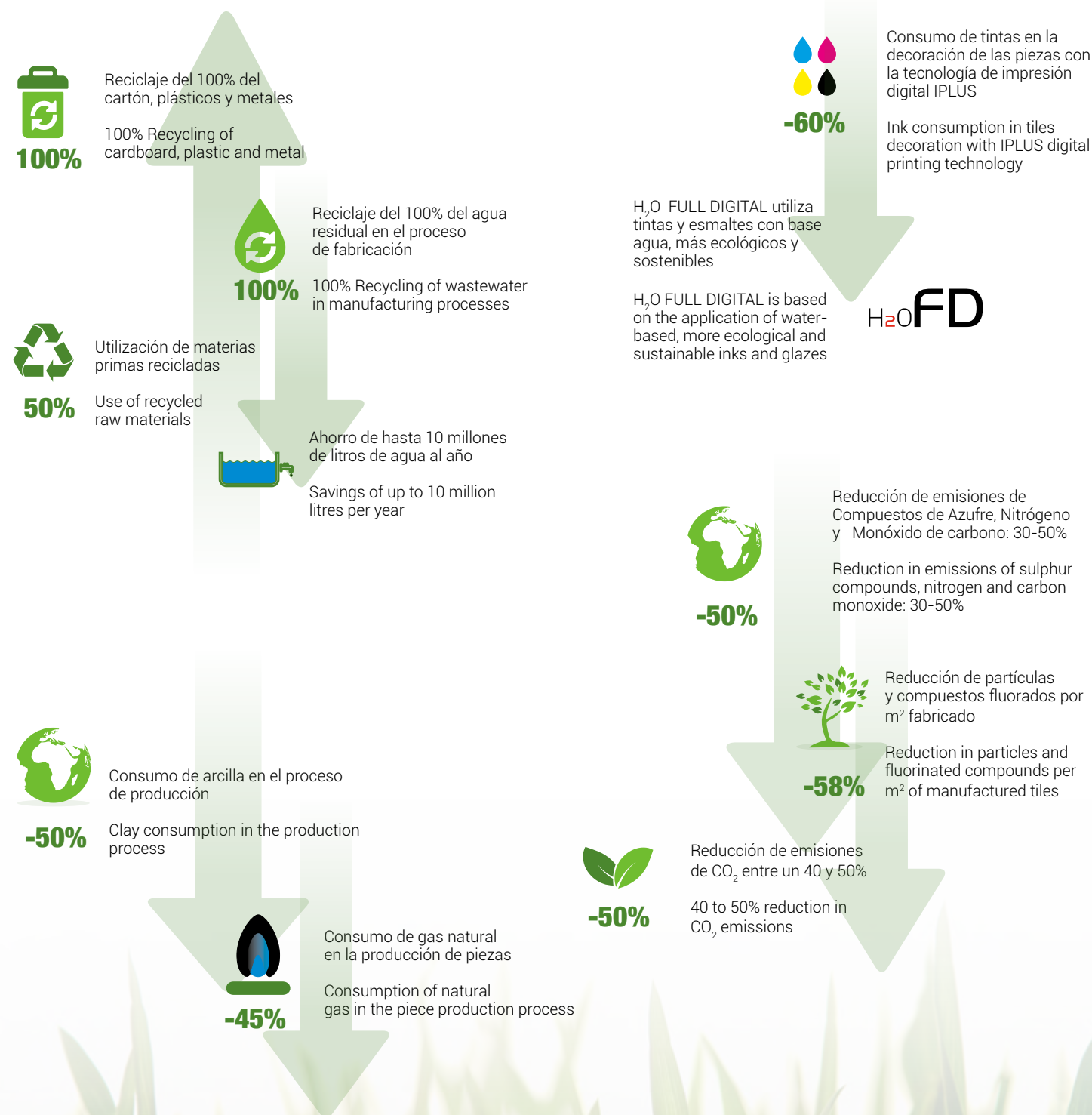
**RECICLAJE Y OPTIMIZACIÓN**

Todos los residuos que se generan en INALCO son tratados por gestores autorizados. El 98% de los residuos generados en el proceso de producción se destinan al reciclado para la elaboración de otros productos y materias primas.

El consumo de los recursos naturales como el agua, las materias primas y la energía se reducen mediante la utilización de las mejores técnicas disponibles. Reducir, reutilizar y reciclar los residuos en origen, planificar los recursos humanos, e integrar la gestión medioambiental en todas las áreas de la empresa son parte del esfuerzo de INALCO por mejorar en este ámbito.

REDUCCIÓN DE EMISIONES

INALCO realiza periódicamente estrictos controles para reducir y minimizar las emisiones, obteniendo resultados muy por debajo de los límites que la legislación marca.

INALCO utiliza filtros que reducen la difusión de polvo a la atmósfera y otros gases responsables del efecto invernadero (GEI).

Además, el desarrollo de las colecciones **iSLIMM** disminuye y minimiza las emisiones de gases GEI muy por debajo de los niveles marcados por el Protocolo de Kyoto. Parte del esfuerzo de INALCO por mejorar en este ámbito.

AHORRO ENERGÉTICO

INALCO utiliza gas natural como fuente de energía en el proceso de cocción por tratarse de la fuente energética menos contaminante.

La inversión en nuevas tecnologías nos permite obtener una mayor productividad, reduciendo tanto el consumo energético como de recursos naturales en el proceso de fabricación de nuestros productos.

INNOVACIÓN Y TECNOLOGÍA

Además de un mayor aprovechamiento de los recursos utilizando las tintas al 100% y de minimizar la generación de residuos, la tecnología H₂O FULL DIGITAL introduce el agua como base para la decoración con tintas y esmaltes. Con ello, se obtienen productos con la máxima definición sin generar emisiones contaminantes y se reduce el consumo de agua durante el proceso productivo hasta en un 70%.

RECYCLING AND OPTIMIZATION

All waste matter generated at INALCO is treated by authorized waste management bodies. 98% of the waste matter generated during the manufacturing process is recycled for the production of other products or raw materials.

Consumption of natural resources, like water, raw materials and energy, is reduced by using the best available techniques. The on-site reduction, re-use and recycling of waste materials, human resource planning, and the integration of INALCO's environmental management system in all areas of the company are some examples of its efforts in this field.

EMISSIONS REDUCTIONS

INALCO carries out strict regular checks to reduce and minimize emissions, achieving results well below legal limits.

INALCO uses filters to reduce the emission of dust and other gases responsible for the greenhouse effect (GHG) into the atmosphere.

In addition, the development of the **iSLIMM** Collections diminishes and minimizes the emissions of GHG gases well below those established by the Kyoto Protocol.

ENERGY SAVINGS

INALCO uses natural gas as a source of energy in the firing process because it is the least pollutant source of energy.

By investing in new technologies, the firm can achieve a higher level of productivity, reducing both the consumption of energy and natural resources in product manufacturing processes.

TECHNOLOGY AND INNOVATION

In addition to a greater use of the resources by using the inks at its 100% and by minimizing the production of residues, the H₂O FULL DIGITAL technology introduces the water as base for the decoration with inks and glazes. With it, INALCO obtains products with the highest definition without generating any polluting emissions and reduces the consumption of water during the production process up to 70%.

POLÍTICA MEDIOAMBIENTAL / ENVIRONMENTAL POLICY

POLÍTICA MEDIOAMBIENTAL / ENVIRONMENTAL POLICY

OBJETIVOS MEDIOAMBIENTALES CONSEGUIDOS CON ISLIMM
ENVIRONMENTAL OBJECTIVES ACHIEVED WITH ISLIMM

OBJETIVOS MEDIOAMBIENTALES CONSEGUIDOS CON ISLIMM
ENVIRONMENTAL OBJECTIVES ACHIEVED WITH ISLIMM



POLÍTICA MEDIOAMBIENTAL / ENVIRONMENTAL POLICY

APORTACIÓN DE LOS PRODUCTOS INALCO A LA OBTENCIÓN DE PUNTOS LEED
CONTRIBUTION OF INALCO'S PRODUCTS TO THE OBTAINMENT OF LEED POINTS



ES

INALCO DECLARA, mediante su política de fabricación ECOINALCO, la contribución de sus productos MDi a la obtención de puntos LEED gracias a su sistema de fabricación basado en la reducción, reutilización y reciclaje de los residuos en origen.

Este documento no constituye por sí mismo una certificación del producto quedando sujeto a la evaluación de cumplimiento de los criterios establecidos por LEED exclusiva del GBCI (Green Business Certification Inc).

EN

INALCO DECLARES that by means of its ECOINALCO manufacturing policy, its high quality MDi products contribute towards obtaining LEED points thanks to their manufacturing system based on the reduction, re-use and recycling of waste material.

This document is not in itself a product certificate, and an assessment must always be made of compliance with the criteria established by LEED exclusive to the GBCI (Green Business Certification Inc).

La información contenida en este documento ha sido elaborada mediante consulta a través del documento LEED V4 del Spain Green Building Council
The information contained in this document has been drawn up following consultations of version 4 of the LEED document issued by the Spain Green Building Council

NC:	Nueva construcción / New construction
CS:	Núcleo y envoltorio / Core and shell
SCHOOLS:	Educativo / Educational
RETAIL:	Superficies comerciales / Shops and stores
DC:	Centros de procesos de datos / Data processing centres
WDC:	Almacenes y centros de distribución / Warehouses and distribution centres
H:	Hospedajes / Lodgings
HEALTHCARE:	Salud / Health

RATYM SYSTEM	NC	CS	SCHOOLS	RETAIL	DC	WDC	H	HEALTHCARE
PUNTOS POSIBLES POSSIBLE POINTS	2	2	2	2	2	2	2	1
CRÉDITO CREDIT	PARCELAS SOSTENIBLES (PS): REDUCCIÓN DE ISLAS DE CALOR SUSTAINABLE SITES (SS): REDUCTION OF HEAT ISLANDS							
	Objetivo Objective	Minimizar los efectos de los microclimas reduciendo las islas de calor. To minimize the effects on microclimates by reducing heat islands.						
	Procedimiento de evaluación Assessment procedure	Cálculo del IRS según ASTM 1980-01. IRS > 30 en colores Crema y Piedra. IRS > 80 en colores Blanco Plus y Blanco. Calculation of SRI as per ASTM 1980-01. SRI > 30 in the case of Crema and Piedra colours. SRI > 80 in the case of Blanco Plus and Blanco.						
	Cumplimiento de requisitos Compliance with requirements	Utilización sobre cubiertas de materiales con índices de reflectancia solar IRS > 32. The use of materials on roofs with a solar reflectance index SRI > 32.						

POLÍTICA MEDIOAMBIENTAL / ENVIRONMENTAL POLICY

APORTACIÓN DE LOS PRODUCTOS INALCO A LA OBTENCIÓN DE PUNTOS LEED
CONTRIBUTION OF INALCO'S PRODUCTS TO THE OBTAINMENT OF LEED POINTS

RATYM SYSTEM	NC	CS	SCHOOLS	RETAIL	DC	WDC	H	HEALTHCARE
PUNTOS POSIBLES POSSIBLE POINTS	1	1	1	1	1	1	1	1
CRÉDITO CREDIT	MATERIALES Y RECURSOS (MR): FUENTES DE MATERIAS PRIMAS MATERIALS & RESOURCES (MR): SOURCES OF RAW MATERIALS							
	Objetivo Objective	Favorecer el uso de productos y materiales verificados con extracción de forma responsable. To encourage the use of products and materials verified as having been extracted or sourced in a responsible way.						
	Procedimiento de evaluación Assessment procedure	Opción 2: Prácticas de liderazgo en extracción. Contenido en reciclados. Option 2: Leadership extraction practices. Recycled content.						
	Cumplimiento de requisitos Compliance with requirements	Contenido en reciclado 30 – 60% pre-consumidor. 30 – 60% recycled pre-consumer content.						

RATYM SYSTEM	NC	CS	SCHOOLS	RETAIL	DC	WDC	H	HEALTHCARE
PUNTOS POSIBLES POSSIBLE POINTS	1-3	1-3	1-3	1-3	1-3	1-3	1-3	1-3
CRÉDITO CREDIT	CALIDAD AMBIENTAL INTERIOR (CAI): MATERIALES DE BAJA EMISION INDOOR ENVIRONMENTAL QUALITY (EQ): LOW EMISSION MATERIALS							
	Objetivo Objective	Reducir las cantidades de contaminantes químicos que puedan perjudicar la calidad del aire, la salud humana y el medioambiente. To reduce concentrations of chemical contaminants that could damage air quality, human health and the environment.						
	Procedimiento de evaluación Assessment procedure	Opción 1: Cálculos por categoría de producto. Mejora de los umbrales de cumplimientos de emisiones. Option 1: Calculations per product category. The improvement of compliance with emission limits.						
	Cumplimiento de requisitos Compliance with requirements	Los materiales MDi de Inalco están considerados fuentes no emisoras inherentemente quedando exentos de las pruebas de emisión COV. Inalco MDi materials are considered to be inherently non-emitting and they are exempt from VOC emission tests.						

POLÍTICA MEDIOAMBIENTAL / ENVIRONMENTAL POLICY

APORTACIÓN DE LOS PRODUCTOS INALCO A LA OBTENCIÓN DE PUNTOS LEED
CONTRIBUTION OF INALCO'S PRODUCTS TO THE OBTAINMENT OF LEED POINTS



RATYM SYSTEM	NC	CS	SCHOOLS	RETAIL	DC	WDC	H	HEALTHCARE
PUNTOS POSIBLES POSSIBLE POINTS	1	1	1	1	1	1	1	1
CRÉDITO CREDIT	CALIDAD AMBIENTAL INTERIOR (CAI): CONFORT TÉRMICO INDOOR ENVIRONMENTAL QUALITY (EQ): THERMAL COMFORT							
	Objetivo Objective	Promover la productividad, el confort y el bienestar de los ocupantes proporcionando un confort térmico de calidad. To promote occupants' productivity, comfort and wellbeing, providing quality thermal comfort.						
	Procedimiento de evaluación Assessment procedure	Proyectar el envoltorio del edificio para dar cumplimiento a la norma ASHRAE 55-2010 Condiciones de Confort Térmico para la Ocupación Humana. To plan the shell of the building in compliance with the ASHRAE 55-2010 standard: Occupant Thermal Comfort Conditions.						
	Cumplimiento de requisitos Compliance with requirements	Los materiales MDI de Inalco utilizados como fachada ventilada contribuyen a mejorar la calidad ambiental del edificio y el confort térmico. Inalco MDI materials used as a ventilated façade help to improve the building's environmental quality and thermal comfort.						

RATYM SYSTEM	NC	CS	SCHOOLS	RETAIL	DC	WDC	H	HEALTHCARE
PUNTOS POSIBLES POSSIBLE POINTS	1-3	1-3	1-3	1-3	1-3	1-3	1-3	1-3
CRÉDITO CREDIT	INNOVACIÓN EN DISEÑO (IN): INNOVACIÓN INNOVATION IN DESIGN (IN): INNOVATION							
	Objetivo Objective	Animar a los edificios a conseguir una eficiencia excepcional e innovadora. To help buildings achieve an outstanding innovative level of efficiency.						
	Procedimiento de evaluación Assessment procedure	Opción 3: Proporcionar estrategias excepcionales por encima de los requisitos establecidos LEED. Option 3: To provide outstanding strategies over and above the requirements established by LEED.						
	Cumplimiento de requisitos Compliance with requirements	Excelente solución en la renovación de espacios merced a su disminución de peso que facilite el corte, perforación y colocación disminuyendo los requisitos estructurales del edificio. Sistemas de colocación sin obras. An outstanding solution for refurbishment projects thanks to its reduction in weight, facilitating cutting, drilling and installation processes and reducing the building's structural requirements. Building-work-free installation systems.						

POLÍTICA MEDIOAMBIENTAL / ENVIRONMENTAL POLICY

APORTACIÓN DE LOS PRODUCTOS INALCO A LA OBTENCIÓN DE PUNTOS LEED
CONTRIBUTION OF INALCO'S PRODUCTS TO THE OBTAINMENT OF LEED POINTS

ESQUEMA DE APORTACIÓN LEED LEED CONTRIBUTION CHART				
CATEGORÍA LEED LEED RATING	CRÉDITO LEED LEED CREDIT	REQUISITO REQUIREMENT	PUNTOS / POINTS	
			Producto Inalco Grosor estándar Inalco product Standard thickness (20 / 10,5 mm)	
PARCELAS SOSTENIBLES SUSTAINABLE SITES	Reducción isla calor Reduction of heat island	Materiales en revestimiento exterior con índice de Refractancia Solar IRS > 32 Outer cladding materials with a Solar Reflectance Index SRI > 32	1-2	1-2
MATERIALES Y RECURSOS MATERIALS AND RESOURCES	Fuentes de materias primas Sources of raw materials	Contenido de reciclado post-consumidor + 1/2 pre-consumidor Post-consumer + 1/2 pre-consumer content	1	1
CALIDAD AMBIENTAL INTERIOR ENVIRONMENTAL QUALITY INTERIORS	Materiales de baja emisión Low-emission materials	No exceder los límites de COV's establecidos para revestimientos interiores The established VOC limits for indoor wall cladding must not be exceeded	1-3	1-3
	Confort térmico Thermal comfort	Proyectar el envoltorio del edificio en cumplimiento de requisitos ASHRAE 5-2010 The building shell must be planned to comply with the requirements of ASHRAE 5-2010	1	1
INNOVACIÓN EN EL DISEÑO INNOVATION IN DESIGN	Innovación Innovation	Proporcionar estrategias excepcionales por encima de los requisitos establecidos en LEED Outstanding strategies must be provided that surpass the requirements established by LEED	-----	1-3





PRODUCTO DISPONIBLE
AVAILABLE PRODUCT





ALEA 6 mm

FORMATO FORMAT	COLOR COLOUR	ACABADO Y GRUPO DE PRECIO M ² FINISHING & PRICE GROUP SQM	PACKING					
			M ² Caja Box	Kg Caja Box	Piezas Caja Pieces Box	Cajas Palet Boxes Palet	M ² Palet Palet	Kg Palet Palet
150 x 150 cm 59" x 59" 	Piedra	Natural Natural 021	45*	725*	20*	1*	45*	725*
100 x 250 cm 39 3/8" x 98 3/8" 	Piedra	114	50*	796*	20*	1*	50*	796*
100 x 100 cm 39 3/8" x 39 3/8" 	Piedra	001	2	27,60	2	24	48	714

Los pesos aquí reflejados pueden sufrir ligeras variaciones en función del lote de producción.
Weights shown here may slightly vary depending on the production lot.

*** 150 x 150 / 100 x 250 cm**

Los datos de packing corresponden a la venta de pallet completo; las cantidades inferiores tendrán un cargo correspondiente a los costes adicionales de manipulación y embalaje de estas piezas (140 €).
The packing data refers to the sale of a complete pallet; an additional charge will be applied to lower quantities to cover the costs of handling and packaging these items (140 €).

COLOR / COLOUR



Alea

Espesor / Thickness





6 mm

Acabado / Finishing

Natural / Natural

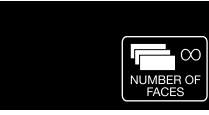

ANANDA 6 mm

FORMATO FORMAT	COLOR COLOUR	ACABADO Y GRUPO DE PRECIO M² FINISHING & PRICE GROUP SQM	PACKING					
			M² Caja Box	Kg Caja Box	Piezas Caja Pieces Box	Cajas Palet Boxes Palet	M² Palet Palet	Kg Palet Palet
150 x 300 cm 59" x 118 1/8" 	Super Blanco-Crema	Arenado 129	72*	1274*	16*	1*	72*	1274*
150 x 150 cm 59" x 59" 	Super Blanco-Crema	Arenado 129	45*	725*	20*	1*	45*	725*
100 x 250 cm 39 3/8" x 98 3/8" 	Super Blanco-Crema	Arenado 115	50*	796*	20*	1*	50*	796*
100 x 100 cm 39 3/8" x 39 3/8" 	Super Blanco-Crema	Arenado 122	2	27,60	2	24	48	714

Los pesos aquí reflejados pueden sufrir ligeras variaciones en función del lote de producción.
Weights shown here may slightly vary depending on the production lot.

*** 150 x 300 / 150 x 150 / 100 x 250 cm**

Los datos de packing corresponden a la venta de pallet completo; las cantidades inferiores tendrán un cargo correspondiente a los costes adicionales de manipulación y embalaje de estas piezas (140 €).
The packing data refers to the sale of a complete pallet; an additional charge will be applied to lower quantities to cover the costs of handling and packaging these items (140 €).

COLOR / COLOUR

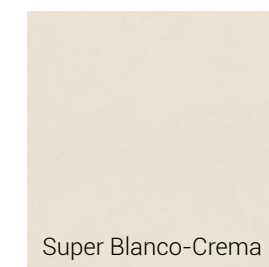

Ananda

Espesor / Thickness

6 mm

Acabado / Finishing

Arenado



ANTAL 6 mm

FORMATO FORMAT	COLOR COLOUR	ACABADO Y GRUPO DE PRECIO M ² FINISHING & PRICE GROUP SQM	PACKING					
			M ² Caja Box	Kg Caja Box	Piezas Caja Pieces Box	Cajas Palet Boxes Palet	M ² Palet Palet	Kg Palet Palet
150 x 150 cm 59" x 59" 	Crema	Abujardado Bush-hammered 021	45*	725*	20*	1*	45*	725*

Los pesos aquí reflejados pueden sufrir ligeras variaciones en función del lote de producción.
Weights shown here may slightly vary depending on the production lot.

*** 150 x 150 cm**

Los datos de packing corresponden a la venta de pallet completo; las cantidades inferiores tendrán un cargo correspondiente a los costes adicionales de manipulación y embalaje de estas piezas (140 €).
The packing data refers to the sale of a complete pallet; an additional charge will be applied to lower quantities to cover the costs of handling and packaging these items (140 €).

ANTAL 10,5 mm

FORMATO FORMAT	COLOR COLOUR	ACABADO Y GRUPO DE PRECIO M ² FINISHING & PRICE GROUP SQM	PACKING					
			M ² Caja Box	Kg Caja Box	Piezas Caja Pieces Box	Cajas Palet Boxes Palet	M ² Palet Palet	Kg Palet Palet
100 x 100 cm 39 3/8" x 39 3/8" 	Crema	Abujardado Bush-hammered 001	2	49	2	24	48	1235

Los pesos aquí reflejados pueden sufrir ligeras variaciones en función del lote de producción.
Weights shown here may slightly vary depending on the production lot.

COLOR / COLOUR

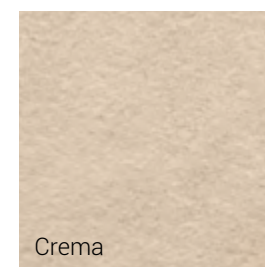

Antal

Espesor / Thickness

10,5 mm

6 mm

Acabado / Finishing

Abujardado / Bush-hammered



Arizona

Espesor / Thickness

6 mm

Acabado / Finishing

Natural / Natural

ARIZONA 6 mm

FORMATO FORMAT	COLOR COLOUR	ACABADO Y GRUPO DE PRECIO M ² FINISHING & PRICE GROUP SQM	PACKING					
			M ² Caja Box	Kg Caja Box	Piezas Caja Pieces Box	Cajas Palet Boxes Palet	M ² Palet Palet	Kg Palet Palet
30 x 300 cm 11 3/4" x 118 1/8"	Fresno	Natural Natural 021	54*	860*	60*	1*	54*	860*
30 x 150 cm 11 3/4" x 59"	Fresno	 114	2,25	32	5	24	54	823

Los pesos aquí reflejados pueden sufrir ligeras variaciones en función del lote de producción.
Weights shown here may slightly vary depending on the production lot.

*** 30 x 300 cm**

Los datos de packing corresponden a la venta de pallet completo; las cantidades inferiores tendrán un cargo correspondiente a los costes adicionales de manipulación y embalaje de estas piezas (140 €).

The packing data refers to the sale of a complete pallet; an additional charge will be applied to lower quantities to cover the costs of handling and packaging these items (140 €).



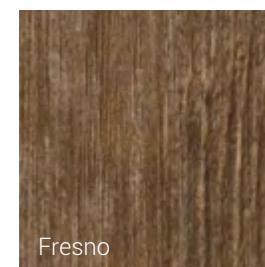

COLOR / COLOUR



Fresno

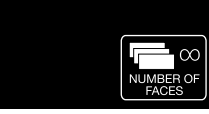

ASTRAL 6 mm

FORMATO FORMAT	COLOR COLOUR	ACABADO Y GRUPO DE PRECIO M ² FINISHING & PRICE GROUP SQM	PACKING					
			M ² Caja Box	Kg Caja Box	Piezas Caja Pieces Box	Cajas Palet Boxes Palet	M ² Palet Palet	Kg Palet Palet
150 x 300 cm 59" x 118 1/8" 	Gris	Natural Natural 021	72*	1274*	16*	1*	72*	1274*
150 x 150 cm 59" x 59" 	Gris	021	45*	725*	20*	1*	45*	725*
100 x 250 cm 39 3/8" x 98 3/8" 	Gris	114	50*	796*	20*	1*	50*	796*
100 x 100 cm 39 3/8" x 39 3/8" 	Gris	001	2	27,60	2	24	48	714

Los pesos aquí reflejados pueden sufrir ligeras variaciones en función del lote de producción.
Weights shown here may slightly vary depending on the production lot.

*** 150 x 300 / 150 x 150 / 100 x 250 cm**

Los datos de packing corresponden a la venta de pallet completo; las cantidades inferiores tendrán un cargo correspondiente a los costes adicionales de manipulación y embalaje de estas piezas (140 €).
The packing data refers to the sale of a complete pallet; an additional charge will be applied to lower quantities to cover the costs of handling and packaging these items (140 €).

COLOR / COLOUR



Astral

Espesor / Thickness

6 mm

Acabado / Finishing

Natural / Natural



Azalai

Espesor / Thickness

6 mm





Acabado / Finishing

Natural / Natural

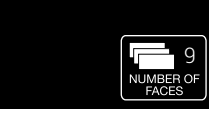

AZALAI 6 mm



FORMATO FORMAT	COLOR COLOUR	ACABADO Y GRUPO DE PRECIO M ² FINISHING & PRICE GROUP SQM	PACKING					
			M ² Caja Box	Kg Caja Box	Piezas Caja Pieces Box	Cajas Palet Boxes Palet	M ² Palet Palet	Kg Palet Palet
150 x 300 cm 59" x 118 1/8" 	Negro	Natural Natural 021	72*	1274*	16*	1*	72*	1274*
150 x 150 cm 59" x 59" 	Negro	Natural Natural 021	45*	725*	20*	1*	45*	725*
100 x 250 cm 39 3/8" x 98 3/8" 	Negro	Natural Natural 114	50*	796*	20*	1*	50*	796*
100 x 100 cm 39 3/8" x 39 3/8" 	Negro	Natural Natural 001	2	27,60	2	24	48	714

Los pesos aquí reflejados pueden sufrir ligeras variaciones en función del lote de producción.
Weights shown here may slightly vary depending on the production lot.

*** 150 x 300 / 150 x 150 / 100 x 250 cm**

Los datos de packing corresponden a la venta de pallet completo; las cantidades inferiores tendrán un cargo correspondiente a los costes adicionales de manipulación y embalaje de estas piezas (140 €).

The packing data refers to the sale of a complete pallet; an additional charge will be applied to lower quantities to cover the costs of handling and packaging these items (140 €).

COLOR / COLOUR

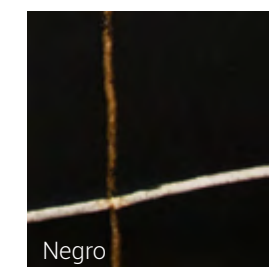



BOSCO 6 mm

FORMATO FORMAT	COLOR COLOUR	ACABADO Y GRUPO DE PRECIO M ² FINISHING & PRICE GROUP SQM	PACKING					
		Natural Natural	M ² Caja Box	Kg Caja Box	Piezas Caja Pieces Box	Cajas Palet Boxes Palet	M ² Palet Palet	Kg Palet Palet
30 x 150 cm 11 3/4" x 59"	Crema	114	2,25	32	5	24	54	823
	Camel							

Los pesos aquí reflejados pueden sufrir ligeras variaciones en función del lote de producción.
Weights shown here may slightly vary depending on the production lot.



Bosco

Espesor / Thickness
6 mm

Acabado / Finishing
Natural / Natural

COLORES / COLOURS

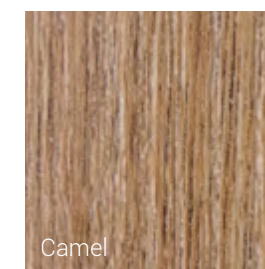
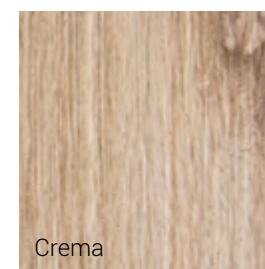

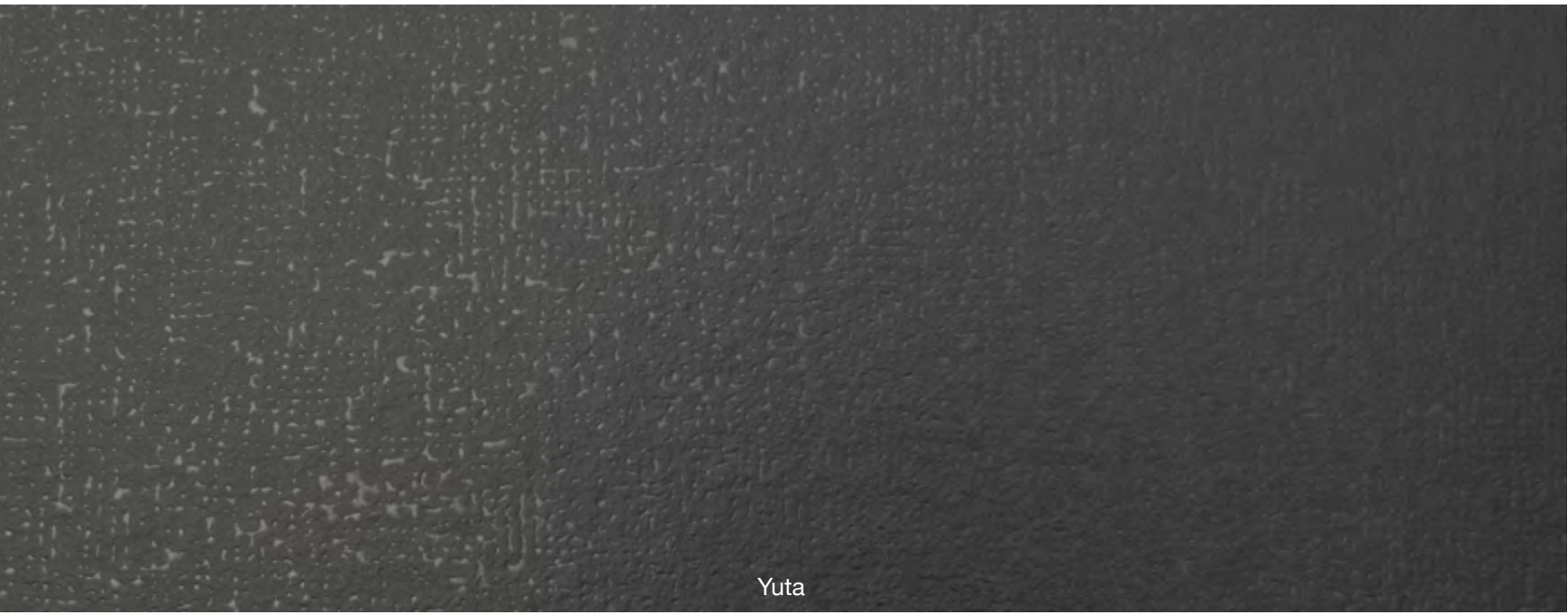

Yuta



Mohair



Rafia

Fibre

Espesor / Thickness

6 mm

Acabado / Finishing

Yuta

Mohair

Rafia

FIBRE 6 mm SLIMM

FORMATO FORMAT	COLOR COLOUR	ACABADO Y GRUPO DE PRECIO M ² FINISHING & PRICE GROUP SQM			PACKING					
		Yuta	Mohair	Rafia	M ² Caja Box	Kg Caja Box	Piezas Caja Pieces Box	Cajas Palet Boxes Palet	M ² Palet Palet	Kg Palet Palet
100 x 250 cm 39 3/8" x 98 3/8"	Blanco		115							
	Visón		114		50*	796*	20*	1*	50*	796*
	Negro		114							

Los pesos aquí reflejados pueden sufrir ligeras variaciones en función del lote de producción.
Weights shown here may slightly vary depending on the production lot.

*** 100 x 250 cm**

Los datos de packing corresponden a la venta de pallet completo; las cantidades inferiores tendrán un cargo correspondiente a los costes adicionales de manipulación y embalaje de estas piezas (140 €).
The packing data refers to the sale of a complete pallet; an additional charge will be applied to lower quantities to cover the costs of handling and packaging these items (140 €).



COLORES / COLOURS

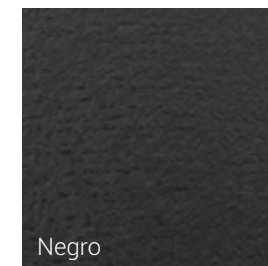
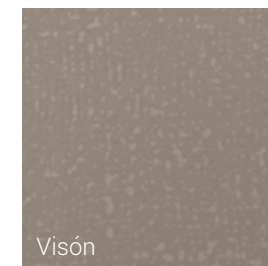
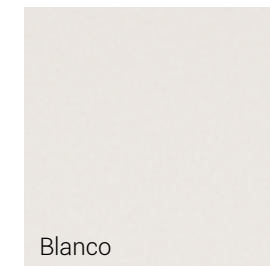



Fluorite

KATTY
SCHIE
BECK | inalco

Espesor / Thickness
6 mm

Acabado / Finishing
Natural / Natural

FLUORITE 6 mm

FORMATO FORMAT	COLOR COLOUR	ACABADO Y GRUPO DE PRECIO M ² FINISHING & PRICE GROUP SQM	PACKING					
			M ² Caja Box	Kg Caja Box	Piezas Caja Pieces Box	Cajas Palet Boxes Palet	M ² Palet Palet	Kg Palet Palet
100 x 250 cm 39 3/8" x 98 3/8" 	Blanco Plus	Natural Natural	50*	796*	20*	1*	50*	796*
	Piedra	114						
	Negro							
100 x 100 cm 39 3/8" x 39 3/8" 	Blanco Plus	Natural Natural	2	27,60	2	24	48	714
	Piedra	001						
	Negro							

Los pesos aquí reflejados pueden sufrir ligeras variaciones en función del lote de producción.
Weights shown here may slightly vary depending on the production lot.

*** 100 x 250 cm**

Los datos de packing corresponden a la venta de pallet completo; las cantidades inferiores tendrán un cargo correspondiente a los costes adicionales de manipulación y embalaje de estas piezas (140 €).
The packing data refers to the sale of a complete pallet; an additional charge will be applied to lower quantities to cover the costs of handling and packaging these items (140 €).

COLORES / COLOURS

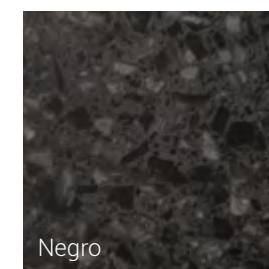
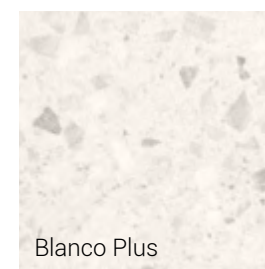



Fusion

Espesor / Thickness
6 mm

Acabado / Finishing
Natural / Natural



FUSION 6 mm



FORMATO FORMAT	COLOR COLOUR	ACABADO Y GRUPO DE PRECIO M ² FINISHING & PRICE GROUP SQM	PACKING					
			M ² Caja Box	Kg Caja Box	Piezas Caja Pieces Box	Cajas Palet Boxes Palet	M ² Palet Palet	Kg Palet Palet
100 x 250 cm 39 3/8" x 98 3/8"	Iris	Natural Natural 114	50*	796*	20*	1*	50*	796*

Los pesos aquí reflejados pueden sufrir ligeras variaciones en función del lote de producción.
Weights shown here may slightly vary depending on the production lot.

*** 100 x 250 cm**

Los datos de packing corresponden a la venta de pallet completo; las cantidades inferiores tendrán un cargo correspondiente a los costes adicionales de manipulación y embalaje de estas piezas (140 €).
The packing data refers to the sale of a complete pallet; an additional charge will be applied to lower quantities to cover the costs of handling and packaging these items (140 €).

COLOR / COLOUR

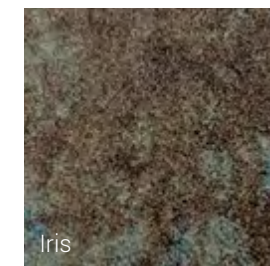



Geo

Espesor / Thickness



6 mm

Acabado / Finishing

Abujardado / Bush-hammered

GEO 6 mm



FORMATO FORMAT	COLOR COLOUR	ACABADO Y GRUPO DE PRECIO M ² FINISHING & PRICE GROUP SQM	PACKING					
			M ² Caja Box	Kg Caja Box	Piezas Caja Pieces Box	Cajas Palet Boxes Palet	M ² Palet Palet	Kg Palet Palet
150 x 300 cm 59" x 118 1/8" 	Crema	Abujardado Bush-hammered 021	72*	1274*	16*	1*	72*	1274*
	Gris							
100 x 250 cm 39 3/8" x 98 3/8" 	Crema	114	50*	796*	20*	1*	50*	796*
	Gris							
100 x 100 cm 39 3/8" x 39 3/8" 	Crema	001	2	27,60	2	24	48	714
	Gris							

Los pesos aquí reflejados pueden sufrir ligeras variaciones en función del lote de producción.
Weights shown here may slightly vary depending on the production lot.

*** 150 x 300 / 100 x 250 cm**

Los datos de packing corresponden a la venta de pallet completo; las cantidades inferiores tendrán un cargo correspondiente a los costes adicionales de manipulación y embalaje de estas piezas. (140 €).
The packing data refers to the sale of a complete pallet; an additional charge will be applied to lower quantities to cover the costs of handling and packaging these items (140 €).

COLORES / COLOURS

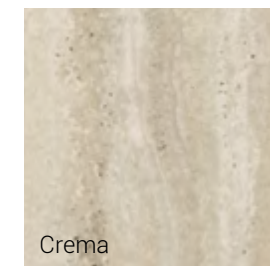



Ground



Espesor / Thickness

6 mm

Acabado / Finishing

Natural / Natural

GROUND 6 mm

FORMATO FORMAT	COLOR COLOUR	ACABADO Y GRUPO DE PRECIO M ² FINISHING & PRICE GROUP SQM	PACKING					
			M ² Caja Box	Kg Caja Box	Piezas Caja Pieces Box	Cajas Palet Boxes Pallet	M ² Palet Pallet	Kg Palet Pallet
100 x 250 cm 39 3/8" x 98 3/8" 	Piedra	Natural Natural 114	50*	796*	20*	1*	50*	796*
100 x 100 cm 39 3/8" x 39 3/8" 	Piedra	001	2	27,60	2	24	48	714

Los pesos aquí reflejados pueden sufrir ligeras variaciones en función del lote de producción.
Weights shown here may slightly vary depending on the production lot.

*** 100 x 250 cm**

Los datos de packing corresponden a la venta de pallet completo; las cantidades inferiores tendrán un cargo correspondiente a los costes adicionales de manipulación y embalaje de estas piezas (140 €).
The packing data refers to the sale of a complete pallet; an additional charge will be applied to lower quantities to cover the costs of handling and packaging these items (140 €).

COLOR / COLOUR

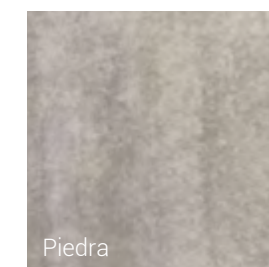



Ice

Espesor / Thickness

6 mm





Acabado / Finishing

Natural / Natural

Pulido Brillo / High-gloss Polished



ICE 6 mm

FORMATO FORMAT	COLOR COLOUR	ACABADO Y GRUPO DE PRECIO M ² FINISHING & PRICE GROUP SQM		PACKING					
		Natural Natural	Pulido Brillo High-gloss Polished	M ² Caja Box	Kg Caja Box	Piezas Caja Pieces Box	Cajas Palet Boxes Palet	M ² Palet Palet	Kg Palet Palet
150 x 300 cm 59" x 118 1/8" 	Super Blanco	130	120	72*	1274*	16*	1*	72*	1274*
150 x 150 cm 59" x 59" 	Super Blanco	130	120	45*	725*	20*	1*	45*	725*
100 x 250 cm 39 3/8" x 98 3/8" 	Super Blanco	131	146	50*	796*	20*	1*	50*	796*
100 x 100 cm 39 3/8" x 39 3/8" 	Super Blanco	134	147	2	27,60	2	24	48	714

Los pesos aquí reflejados pueden sufrir ligeras variaciones en función del lote de producción.
Weights shown here may slightly vary depending on the production lot.

*** 150 x 300 / 150 x 150 / 100 x 250 cm**

Los datos de packing corresponden a la venta de pallet completo; las cantidades inferiores tendrán un cargo correspondiente a los costes adicionales de manipulación y embalaje de estas piezas (140 €).
The packing data refers to the sale of a complete pallet; an additional charge will be applied to lower quantities to cover the costs of handling and packaging these items (140 €).

COLOR / COLOUR

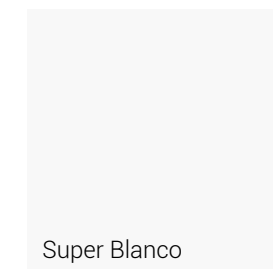

Super Blanco



Iseo

Espesor / Thickness

10,5 mm

6 mm

Acabado / Finishing

Abujardado / Bush-hammered

Non-slip



ISEO 6 mm

SLIMM

FORMATO FORMAT	COLOR COLOUR	ACABADO Y GRUPO DE PRECIO M ² FINISHING & PRICE GROUP SQM		PACKING					
		Abujardado Bush-hammered	Non-slip	M ² Caja Box	Kg Caja Box	Piezas Caja Pieces Box	Cajas Palet Boxes Palet	M ² Palet Palet	Kg Palet Palet
150 x 300 cm 59" x 118 1/8"	Gris	021	----	72*	1274*	16*	1*	72*	1274*
150 x 150 cm 59" x 59"	Gris	021	----	45*	725*	20*	1*	45*	725*
100 x 250 cm 39 3/8" x 98 3/8"	Gris	114	----	50*	796*	20*	1*	50*	796*

Los pesos aquí reflejados pueden sufrir ligeras variaciones en función del lote de producción.
Weights shown here may slightly vary depending on the production lot.

* 150 x 300 / 150 x 150 / 100 x 250 cm

Los datos de packing corresponden a la venta de pallet completo; las cantidades inferiores tendrán un cargo correspondiente a los costes adicionales de manipulación y embalaje de estas piezas (140 €).
The packing data refers to the sale of a complete pallet; an additional charge will be applied to lower quantities to cover the costs of handling and packaging these items (140 €).

COLOR / COLOUR

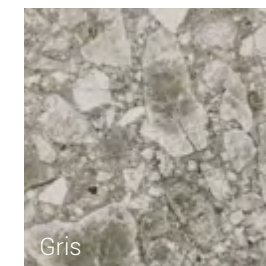

Gris



ISEO 6 mm

FORMATO FORMAT	COLOR COLOUR	ACABADO Y GRUPO DE PRECIO M ² FINISHING & PRICE GROUP SQM		PACKING					
		Abujardado Bush-hammered	Non-slip	M ² Caja Box	Kg Caja Box	Piezas Caja Pieces Box	Cajas Palet Boxes Pallet	M ² Palet Pallet	Kg Palet Pallet
100 x 100 cm 39 3/8" x 39 3/8" 	Gris	001	----	2	27,60	2	24	48	714
20 x 20 cm 7 7/8" x 7 7/8" 	Gris	194	----	1	14,20	25	96	96	1386
10 x 20 cm 3 7/8" x 7 7/8" 	Gris	194	----	1	14,20	50	96	96	1386

Los pesos aquí reflejados pueden sufrir ligeras variaciones en función del lote de producción.
Weights shown here may slightly vary depending on the production lot.

ISEO 10,5 mm

FORMATO FORMAT	COLOR COLOUR	ACABADO Y GRUPO DE PRECIO M ² FINISHING & PRICE GROUP SQM		PACKING					
		Abujardado Bush-hammered	Non-slip	M ² Caja Box	Kg Caja Box	Piezas Caja Pieces Box	Cajas Palet Boxes Pallet	M ² Palet Pallet	Kg Palet Pallet
100 x 100 cm 39 3/8" x 39 3/8" 	Gris	001		2	49	2	24	48	1235

Los pesos aquí reflejados pueden sufrir ligeras variaciones en función del lote de producción.
Weights shown here may slightly vary depending on the production lot.

COLOR / COLOUR

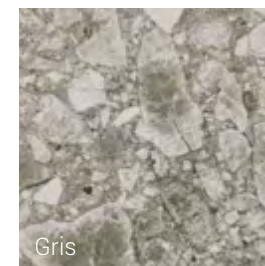

Esta colección dispone de acabado antideslizante. Iseo Gris Non-slip 100 x 100 cm (10,5 mm) Clase 3 - R12 - A + B + C. Consultar en la página 238.
A non-slip finishing is available for this collection. Iseo Gris Non-slip 100 x 100 cm (10,5 mm) Class 3 - R12 - A + B + C. Check on page 238.



Jasper

Espesor / Thickness

10,5 mm



6 mm

Acabado / Finishing

Abujardado / Bush-hammered

Non-slip

JASPER 6 mm

FORMATO FORMAT	COLOR COLOUR	ACABADO Y GRUPO DE PRECIO M ² FINISHING & PRICE GROUP SQM	PACKING					
			M ² Caja Box	Kg Caja Box	Piezas Caja Pieces Box	Cajas Palet Boxes Palet	M ² Palet Palet	Kg Palet Palet
150 x 150 cm 59" x 59" 	Moka	Abujardado Bush-hammered 021	45*	725*	20*	1*	45*	725*
	Deco Moka	-----						
100 x 250 cm 39 3/8" x 98 3/8" 	Moka	114	50*	796*	20*	1*	50*	796*
	Deco Moka	-----						
100 x 100 cm 39 3/8" x 39 3/8" 	Moka	001	2	27,60	2	24	48	714
	Deco Moka	-----						

Los pesos aquí reflejados pueden sufrir ligeras variaciones en función del lote de producción.
Weights shown here may slightly vary depending on the production lot.

*** 150 x 150 / 100 x 250 cm**

Los datos de packing corresponden a la venta de pallet completo; las cantidades inferiores tendrán un cargo correspondiente a los costes adicionales de manipulación y embalaje de estas piezas (140 €).
The packing data refers to the sale of a complete pallet; an additional charge will be applied to lower quantities to cover the costs of handling and packaging these items (140 €).

COLORES / COLOURS

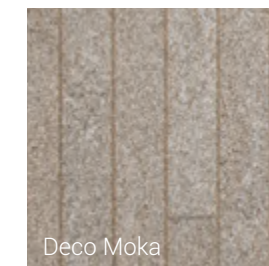
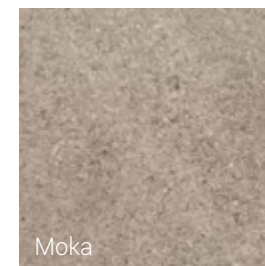

**JASPER 10,5 mm**

FORMATO FORMAT	COLOR COLOUR	ACABADO Y GRUPO DE PRECIO M ² FINISHING & PRICE GROUP SQM		PACKING					
		Abujardado Bush-hammered	Non-slip	M ² Caja Box	Kg Caja Box	Piezas Caja Pieces Box	Cajas Palet Boxes Pallet	M ² Palet Pallet	Kg Palet Pallet
100 x 100 cm 39 3/8" x 39 3/8" 	Moka		001	2	49	2	24	48	1235

Los pesos aquí reflejados pueden sufrir ligeras variaciones en función del lote de producción.
Weights shown here may slightly vary depending on the production lot.

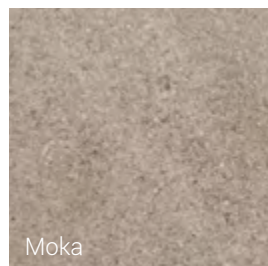
COLOR / COLOUR

Esta colección dispone de acabado antideslizante. Jasper Moka Non-slip 100 x 100 cm (10,5 mm)
Clase 3 - R12 - A + B + C. Consultar en la página 238.
A non-slip finishing is available for this collection. Jasper Moka Non-slip 100 x 100 cm (10,5 mm)
Class 3 - R12 - A + B + C. Check on page 238.



Joy

Espesor / Thickness
10,5 mm

Acabado / Finishing
Natural / Natural

JOY 10,5 mm

FORMATO FORMAT	COLOR COLOUR	ACABADO Y GRUPO DE PRECIO M ² FINISHING & PRICE GROUP SQM	PACKING					
			M ² Caja Box	Kg Caja Box	Piezas Caja Pieces Box	Cajas Palet Boxes Palet	M ² Palet Palet	Kg Palet Palet
100 x 100 cm 39 3/8" x 39 3/8"	Piedra	Natural Natural 001	2	49	2	24	48	1235

Los pesos aquí reflejados pueden sufrir ligeras variaciones en función del lote de producción.
Weights shown here may slightly vary depending on the production lot.

COLOR / COLOUR

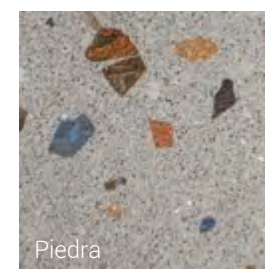

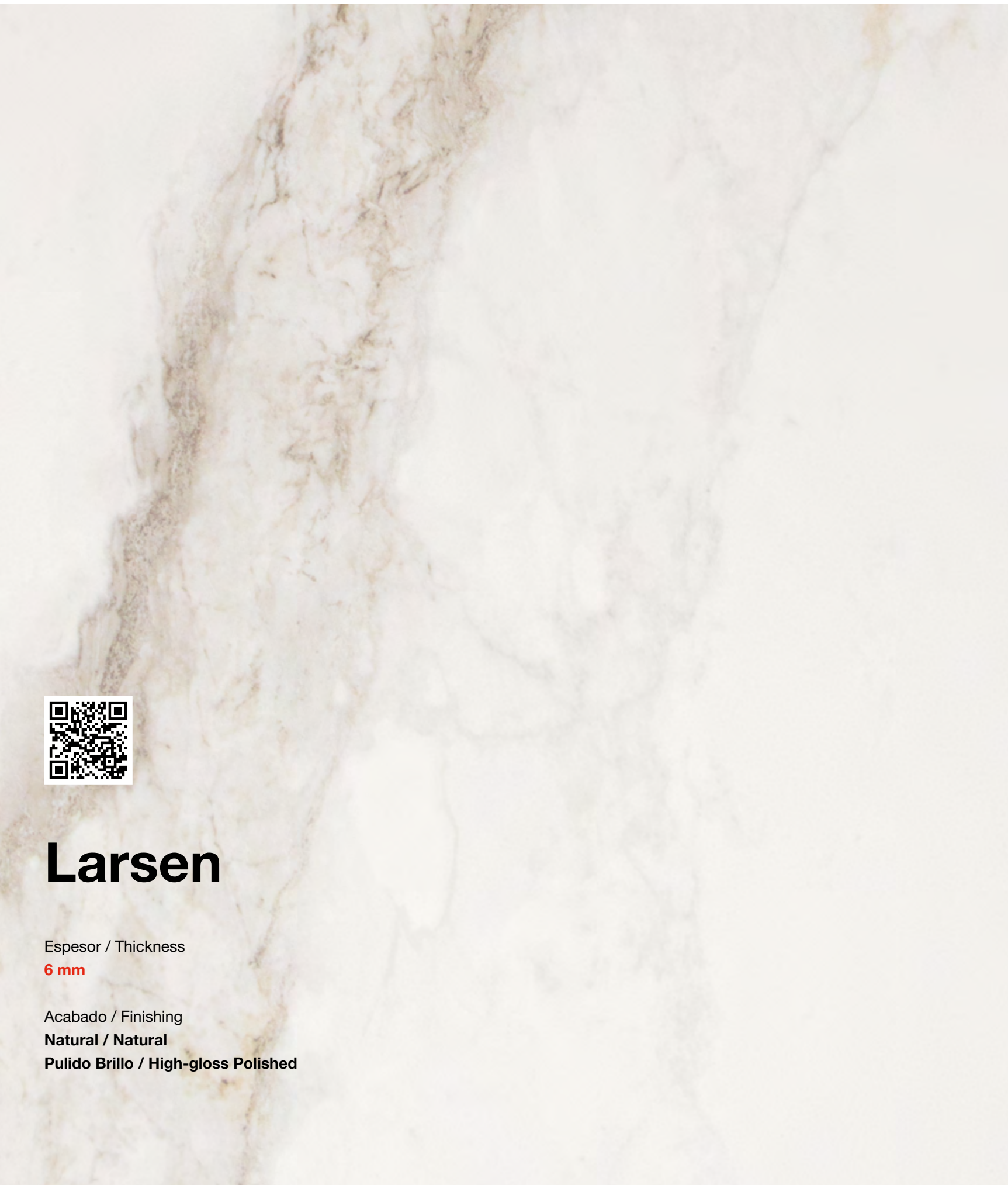

Larsen

Espesor / Thickness





6 mm

Acabado / Finishing

Natural / Natural

Pulido Brillo / High-gloss Polished

LARSEN 6 mm

FORMATO FORMAT	COLOR COLOUR	ACABADO Y GRUPO DE PRECIO M ² FINISHING & PRICE GROUP SQM		PACKING					
		Natural Natural	Pulido Brillo High-gloss Polished	M ² Caja Box	Kg Caja Box	Piezas Caja Pieces Box	Cajas Palet Boxes Pallet	M ² Palet Pallet	Kg Palet Pallet
150 x 300 cm 59" x 118 1/8" 	Super Blanco-Gris	129	121	72*	1274*	16*	1*	72*	1274*
150 x 150 cm 59" x 59" 	Super Blanco-Gris	129	121	45*	725*	20*	1*	45*	725*
100 x 250 cm 39 3/8" x 98 3/8" 	Super Blanco-Gris	115	116	50*	796*	20*	1*	50*	796*
100 x 100 cm 39 3/8" x 39 3/8" 	Super Blanco-Gris	122	128	2	27,60	2	24	48	714

Los pesos aquí reflejados pueden sufrir ligeras variaciones en función del lote de producción.
Weights shown here may slightly vary depending on the production lot.

*** 150 x 300 / 150 x 150 / 100 x 250 cm**

Los datos de packing corresponden a la venta de pallet completo; las cantidades inferiores tendrán un cargo correspondiente a los costes adicionales de manipulación y embalaje de estas piezas. (140 €).
The packing data refers to the sale of a complete pallet; an additional charge will be applied to lower quantities to cover the costs of handling and packaging these items (140 €).

COLOR / COLOUR

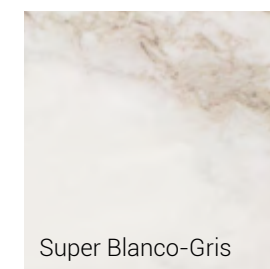



LARSEN (BOOKMATCH) 6 mm



FORMATO FORMAT	COLOR COLOUR	ACABADO Y GRUPO DE PRECIO M ² FINISHING & PRICE GROUP SQM		PACKING					
		Natural Natural	Pulido Brillo High-gloss Polished	M ² Caja Box	Kg Caja Box	Piezas Caja Pieces Box	Cajas Palet Boxes Pallet	M ² Palet Pallet	Kg Palet Pallet
150 x 300 cm 59" x 118 1/8"	Super Blanco-Gris A	144	145	72*	1274*	16*	1*	72*	1274*
	Super Blanco-Gris B								
100 x 250 cm 39 3/8" x 98 3/8"	Super Blanco-Gris A	142	143	50*	796*	20*	1*	50*	796*
	Super Blanco-Gris B								

*** 150 x 300 / 100 x 250 cm**

Los datos de packing corresponden a la venta de pallet completo; las cantidades inferiores tendrán un cargo correspondiente a los costes adicionales de manipulación y embalaje de estas piezas (140 €).

The packing data refers to the sale of a complete pallet; an additional charge will be applied to lower quantities to cover the costs of handling and packaging these items (140 €).

Los formatos 150 x 300 y 100 x 250 cm de la colección Larsen en los acabados Natural y Pulido Brillo permite la colocación bookmatch o efecto espejo. Para conseguir este efecto, se colocan piezas A y B del mismo color y acabado. Por ejemplo: Super Blanco-Gris A Pulido Brillo y Super Blanco-Gris B Pulido Brillo. Larsen Series in a 150 x 300 and 100 x 250 cm formats and Natural and High-gloss Polished finishings can be used to create a bookmatching mirror effect. To achieve this effect, A + B references with the same colour and finishing must be used. For example: Super Blanco-Gris A High-gloss Polished and Super Blanco-Gris B High-gloss Polished.

LARSEN BOOKMATCH VERTICAL 150x300 cm

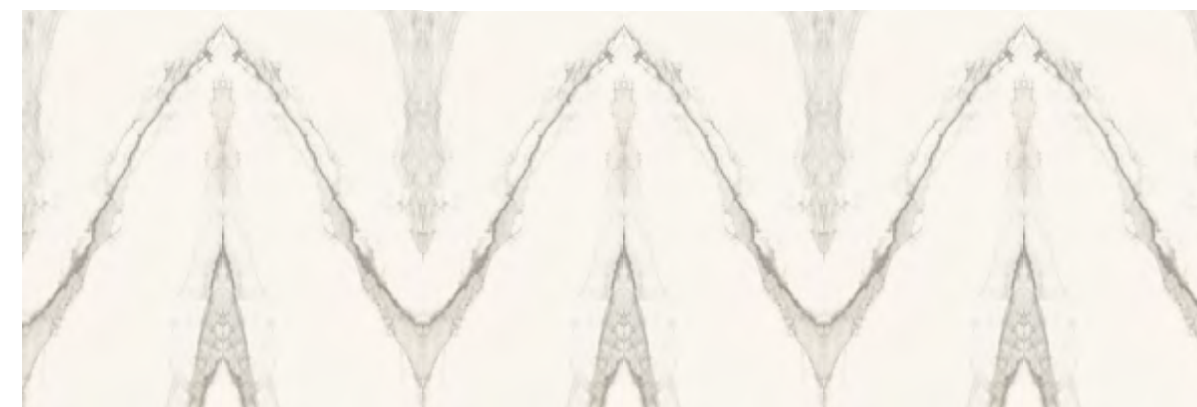

Super Blanco-Gris A Super Blanco-Gris B Super Blanco-Gris A Super Blanco-Gris B Super Blanco-Gris A Super Blanco-Gris B

LARSEN BOOKMATCH VERTICAL 150x300 cm



Super Blanco-Gris A Super Blanco-Gris B Super Blanco-Gris A Super Blanco-Gris B

LARSEN BOOKMATCH VERTICAL 100x250 cm

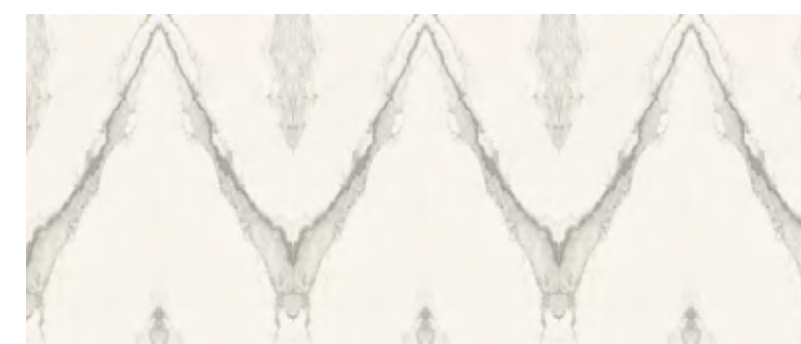

Super Blanco-Gris A Super Blanco-Gris B Super Blanco-Gris A Super Blanco-Gris B Super Blanco-Gris A Super Blanco-Gris B

LARSEN BOOKMATCH VERTICAL 100x250 cm



Super Blanco-Gris A Super Blanco-Gris B Super Blanco-Gris A Super Blanco-Gris B

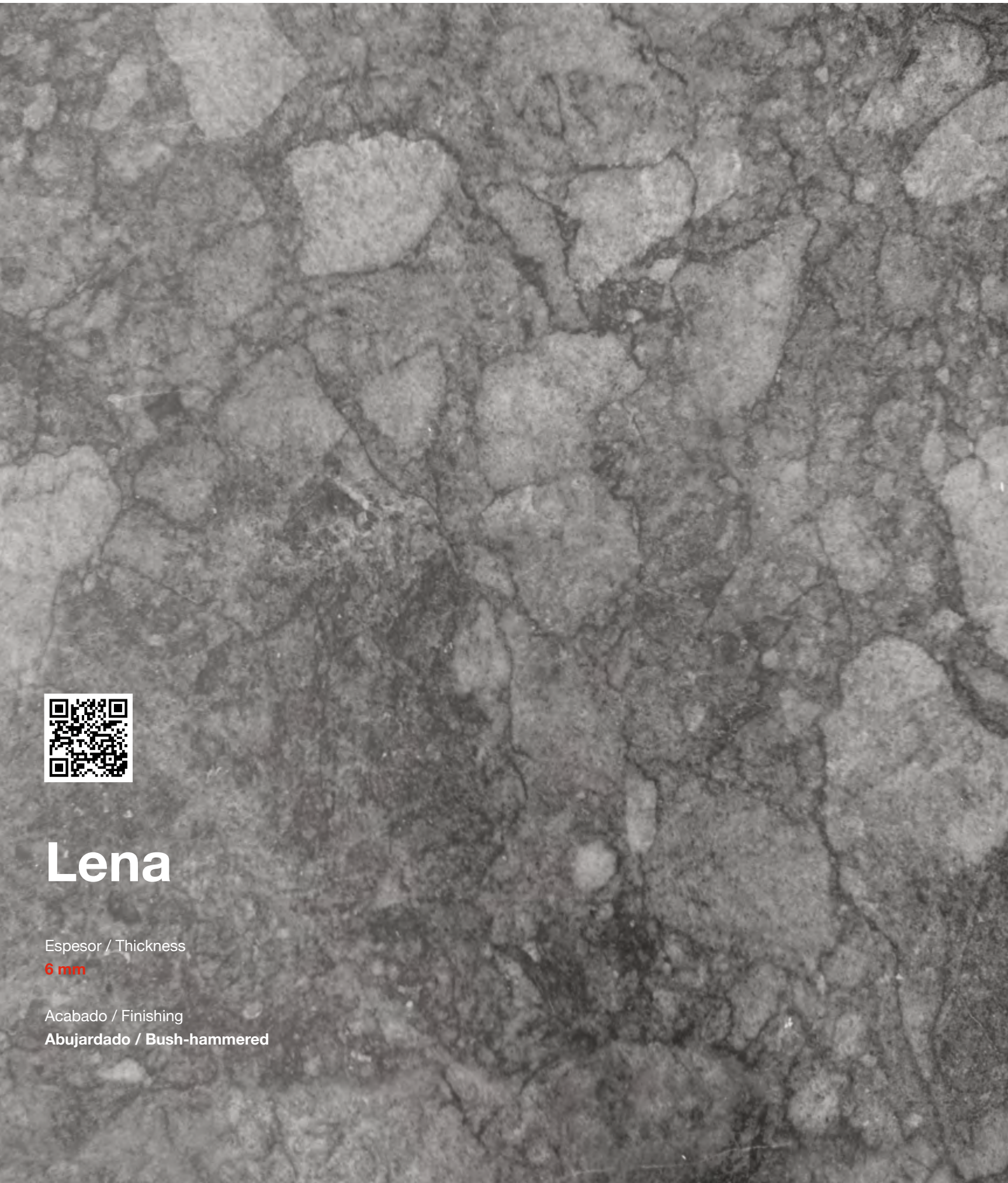

Lena

Espesor / Thickness

6 mm

Acabado / Finishing

Abujardado / Bush-hammered

LENA 6 mm

FORMATO FORMAT	COLOR COLOUR	ACABADO Y GRUPO DE PRECIO M ² FINISHING & PRICE GROUP SQM	PACKING					
			M ² Caja Box	Kg Caja Box	Piezas Caja Pieces Box	Cajas Palet Boxes Palet	M ² Palet Palet	Kg Palet Palet
150 x 300 cm 59" x 118 1/8"	Gris	Abujardado Bush-hammered 021	72*	1274*	16*	1*	72*	1274*
150 x 150 cm 59" x 59"	Gris	021	45*	725*	20*	1*	45*	725*

Los pesos aquí reflejados pueden sufrir ligeras variaciones en función del lote de producción.
Weights shown here may slightly vary depending on the production lot.

*** 150 x 300 / 150 x 150 cm**

Los datos de packing corresponden a la venta de pallet completo; las cantidades inferiores tendrán un cargo correspondiente a los costes adicionales de manipulación y embalaje de estas piezas (140 €).
The packing data refers to the sale of a complete pallet; an additional charge will be applied to lower quantities to cover the costs of handling and packaging these items (140 €).

COLOR / COLOUR

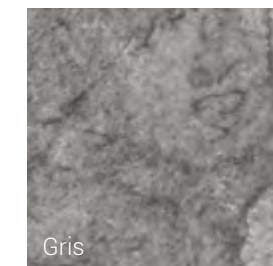



Masai

Espesor / Thickness

10,5 mm

6 mm

Acabado / Finishing

Abujardado / Bush-hammered

Non-slip

MASAI 6 mm

FORMATO FORMAT	COLOR COLOUR	ACABADO Y GRUPO DE PRECIO M ² FINISHING & PRICE GROUP SQM		PACKING					
		Abujardado Bush-hammered		M ² Caja Box	Kg Caja Box	Piezas Caja Pieces Box	Cajas Palet Boxes Palet	M ² Palet Palet	Kg Palet Palet
150 x 150 cm 59" x 59" 	Blanco Plus	021		45*	725*	20*	1*	45*	725*
	Piedra								
100 x 250 cm 39 3/8" x 98 3/8" 	Blanco Plus	114		50*	796*	20*	1*	50*	796*
	Piedra								

*** 150 x 150 / 100 x 250 cm**

Los datos de packing corresponden a la venta de pallet completo; las cantidades inferiores tendrán un cargo correspondiente a los costes adicionales de manipulación y embalaje de estas piezas (140 €).

The packing data refers to the sale of a complete pallet; an additional charge will be applied to lower quantities to cover the costs of handling and packaging these items (140 €).

MASAI 10,5 mm

FORMATO FORMAT	COLOR COLOUR	ACABADO Y GRUPO DE PRECIO M ² FINISHING & PRICE GROUP SQM		PACKING					
		Abujardado Bush-hammered	Non-slip	M ² Caja Box	Kg Caja Box	Piezas Caja Pieces Box	Cajas Palet Boxes Palet	M ² Palet Palet	Kg Palet Palet
100 x 100 cm 39 3/8" x 39 3/8" 	Blanco Plus	001		2	49	2	24	48	1235
	Piedra	001	-----						

Los pesos aquí reflejados pueden sufrir ligeras variaciones en función del lote de producción.
Weights shown here may slightly vary depending on the production lot.

COLORES / COLOURS

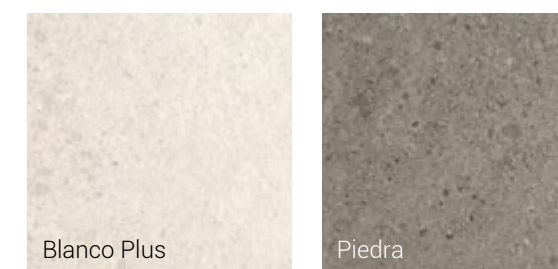

Esta colección dispone de acabado antideslizante.
Masai Blanco Plus Non-slip 100 x 100 cm (10,5 mm) Clase 3 - R12 - A + B + C.
Consultar en la página 238.
A non-slip finishing is available for this collection.
Masai Blanco Plus Non-slip 100 x 100 cm (10,5 mm) Class 3 - R12 - A + B + C.
Check on page 238.



Meteora

Espesor / Thickness

10,5 mm





6 mm

Acabado / Finishing

Abujardado / Bush-hammered

Non-slip

METEORA 6 mm

FORMATO FORMAT	COLOR COLOUR	ACABADO Y GRUPO DE PRECIO M ² FINISHING & PRICE GROUP SQM		PACKING					
		Abujardado Bush-hammered	Non-slip	M ² Caja Box	Kg Caja Box	Piezas Caja Pieces Box	Cajas Palet Boxes Palet	M ² Palet Palet	Kg Palet Palet
150 x 300 cm 59" x 118 1/8" 	Gris	021	----	72*	1274*	16*	1*	72*	1274*
150 x 150 cm 59" x 59" 	Gris	021	----	45*	725*	20*	1*	45*	725*
100 x 250 cm 39 3/8" x 98 3/8" 	Gris	114	----	50*	796*	20*	1*	50*	796*
100 x 100 cm 39 3/8" x 39 3/8" 	Gris	001	----	2	27,60	2	24	48	714

Los pesos aquí reflejados pueden sufrir ligeras variaciones en función del lote de producción.
Weights shown here may slightly vary depending on the production lot.

*** 150 x 300 / 150 x 150 / 100 x 250 cm**

Los datos de packing corresponden a la venta de pallet completo; las cantidades inferiores tendrán un cargo correspondiente a los costes adicionales de manipulación y embalaje de estas piezas (140 €).

The packing data refers to the sale of a complete pallet; an additional charge will be applied to lower quantities to cover the costs of handling and packaging these items (140 €).

COLOR / COLOUR

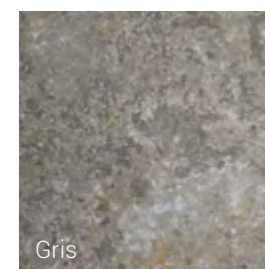

Gris

**METEORA 10,5 mm**

FORMATO FORMAT	COLOR COLOUR	ACABADO Y GRUPO DE PRECIO M ² FINISHING & PRICE GROUP SQM		PACKING					
		Abujardado Bush-hammered	Non slip	M ² Caja Box	Kg Caja Box	Piezas Caja Pieces Box	Cajas Palet Boxes Pallet	M ² Palet Pallet	Kg Palet Pallet
100 x 100 cm 39 3/8" x 39 3/8" 	Gris	-----	001	2	49	2	24	48	1235

Los pesos aquí reflejados pueden sufrir ligeras variaciones en función del lote de producción.
Weights shown here may slightly vary depending on the production lot.

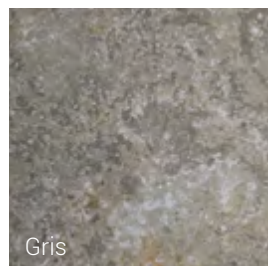
COLOR / COLOUR

Esta colección dispone de acabado antideslizante. Meteora Gris Non-slip 100 x 100 cm (10,5 mm) Clase 3 - R12 - A + B + C. Consultar en la página 238.
A non-slip finishing is available for this collection. Meteora Gris Non-slip 100 x 100 cm (10,5 mm) Class 3 - R12 - A + B + C. Check on page 238.



Moon

Espesor / Thickness

20 mm



6 mm

Acabado / Finishing

Abujardado / Bush-hammered

Non-slip

MOON 6 mm

FORMATO FORMAT	COLOR COLOUR	ACABADO Y GRUPO DE PRECIO M ² FINISHING & PRICE GROUP SQM		PACKING					
		Abujardado Bush-hammered	Non-slip	Non-slip	Kg Caja Box	Piezas Caja Pieces Box	Cajas Palet Boxes Palet	M ² Palet Pallet	Kg Palet Pallet
150 x 150 cm 59" x 59" 	Gris	021	----	45*	725*	20*	1*	45*	725*
100 x 250 cm 39 3/8" x 98 3/8" 	Gris	114	----	50*	796*	20*	1*	50*	796*
100 x 100 cm 39 3/8" x 39 3/8" 	Gris	001	----	2	27,60	2	24	48	714

Los pesos aquí reflejados pueden sufrir ligeras variaciones en función del lote de producción.
Weights shown here may slightly vary depending on the production lot.

*** 150 x 150 / 100 x 250 cm**

Los datos de packing corresponden a la venta de pallet completo; las cantidades inferiores tendrán un cargo correspondiente a los costes adicionales de manipulación y embalaje de estas piezas (140 €).

The packing data refers to the sale of a complete pallet; an additional charge will be applied to lower quantities to cover the costs of handling and packaging these items (140 €).

COLOR / COLOUR

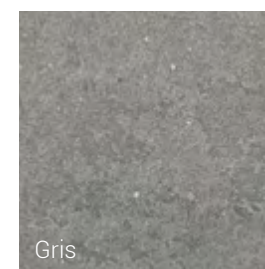

Gris



MOON 6 mm



FORMATO FORMAT	COLOR COLOUR	ACABADO Y GRUPO DE PRECIO M ² FINISHING & PRICE GROUP SQM		PACKING					
		Abujardado Bush-hammered	Non-slip	M ² Caja Box	Kg Caja Box	Piezas Caja Pieces Box	Cajas Palet Boxes Pallet	M ² Palet Pallet	Kg Palet Pallet
20 x 20 cm 7 7/8" x 7 7/8" 	Gris	194	----	1	14,20	25	96	96	1386
10 x 20 cm 3 7/8" x 7 7/8" 	Gris	194	----	1	14,20	50	96	96	1386

Los pesos aquí reflejados pueden sufrir ligeras variaciones en función del lote de producción.
Weights shown here may slightly vary depending on the production lot.

MOON 20 mm

FORMATO FORMAT	COLOR COLOUR	ACABADO Y GRUPO DE PRECIO M ² FINISHING & PRICE GROUP SQM		PACKING					
		Abujardado Bush-hammered	Non-slip	Non-slip	Kg Caja Box	Piezas Caja Pieces Box	Cajas Palet Boxes Pallet	M ² Palet Pallet	Kg Palet Pallet
20 x 30 cm 7 7/8" x 11 3/4" 	Gris	----	195	0,24	11,16	4	128	30,72	1360
20 x 20 cm 7 7/8" x 7 7/8" 	Gris	----	195	0,24	11,17	6	120	28,80	1361

Los pesos aquí reflejados pueden sufrir ligeras variaciones en función del lote de producción.
Weights shown here may slightly vary depending on the production lot.



COLOR / COLOUR



Esta colección dispone de acabado antideslizante. Moon Gris Non-slip 20 x 30 / 20 x 20 cm (20 mm) Clase 3 - R12 - A + B + C. Consultar en la página 238.
A non-slip finishing is available for this collection. Moon Gris Non-slip 20 x 30 / 20 x 20 cm (20 mm) Class 3 - R12 - A + B + C. Check on page 238.



OXIDE 6 mm

FORMATO FORMAT	COLOR COLOUR	ACABADO Y GRUPO DE PRECIO M ² FINISHING & PRICE GROUP SQM	PACKING					
			M ² Caja Box	Kg Caja Box	Piezas Caja Pieces Box	Cajas Palet Boxes Palet	M ² Palet Palet	Kg Palet Palet
150 x 300 cm 59" x 118 1/8" 	Corten	021	72*	1274*	16*	1*	72*	1274*
100 x 250 cm 39 3/8" x 98 3/8" 	Corten	114	50*	796*	20*	1*	50*	796*

Los pesos aquí reflejados pueden sufrir ligeras variaciones en función del lote de producción.
Weights shown here may slightly vary depending on the production lot.

*** 150 x 300 / 100 x 250 cm**

Los datos de packing corresponden a la venta de pallet completo; las cantidades inferiores tendrán un cargo correspondiente a los costes adicionales de manipulación y embalaje de estas piezas (140 €).
The packing data refers to the sale of a complete pallet; an additional charge will be applied to lower quantities to cover the costs of handling and packaging these items (140 €).



Oxide

Espesor / Thickness

6 mm

Acabado / Finishing

Natural / Natural

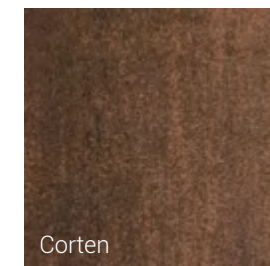

COLOR / COLOUR





PACIFIC 6 mm



FORMATO FORMAT	COLOR COLOUR	ACABADO Y GRUPO DE PRECIO M ² FINISHING & PRICE GROUP SQM			PACKING					
		Natural Natural	Abujardado Bush-hammered	Non-slip	M ² Caja Box	Kg Caja Box	Piezas Caja Pieces Box	Cajas Palet Boxes Palet	M ² Palet Palet	Kg Palet Palet
150 x 300 cm 59" x 118 1/8" 	Blanco Plus	----	021	----	72*	1274*	16*	1*	72*	1274*
	Gris									
150 x 150 cm 59" x 59" 	Blanco Plus	021	----	----	45*	725*	20*	1*	45*	725*
	Gris									
100 x 250 cm 39 3/8" x 98 3/8" 	Blanco Plus	114	----	----	50*	796*	20*	1*	50*	796*
	Gris									

Los pesos aquí reflejados pueden sufrir ligeras variaciones en función del lote de producción.
Weights shown here may slightly vary depending on the production lot.

*** 150 x 300 / 150 x 150 / 100 x 250 cm**

Los datos de packing corresponden a la venta de pallet completo; las cantidades inferiores tendrán un cargo correspondiente a los costes adicionales de manipulación y embalaje de estas piezas (140 €).
The packing data refers to the sale of a complete pallet; an additional charge will be applied to lower quantities to cover the costs of handling and packaging these items (140 €).

COLORES / COLOURS

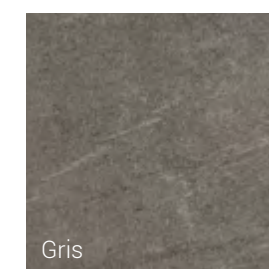
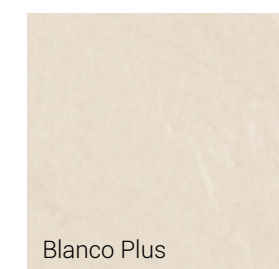

Pacific

Espesor / Thickness

- 20 mm
- 10,5 mm
- 6 mm**

Acabado / Finishing

- Natural / Natural
- Abujardado / Bush-hammered
- Non-slip

PACIFIC 20 mm

FORMATO FORMAT	COLOR COLOUR	ACABADO Y GRUPO DE PRECIO M ² FINISHING & PRICE GROUP SQM			PACKING					
		Natural Natural	Abujardado Bush-hammered	Non-slip	M ² Caja Box	Kg Caja Box	Piezas Caja Pieces Box	Cajas Palet Boxes Pallet	M ² Palet Pallet	Kg Palet Pallet
100 x 100 cm 39 3/8" x 39 3/8" 	Blanco Plus	-----		306	1	50	1	24	24	1254,72
	Gris	-----								

PACIFIC 10,5 mm

FORMATO FORMAT	COLOR COLOUR	ACABADO Y GRUPO DE PRECIO M ² FINISHING & PRICE GROUP SQM			PACKING					
		Natural Natural	Abujardado Bush-hammered	Non-slip	M ² Caja Box	Kg Caja Box	Piezas Caja Pieces Box	Cajas Palet Boxes Pallet	M ² Palet Pallet	Kg Palet Pallet
100 x 100 cm 39 3/8" x 39 3/8" 	Blanco Plus	001			2	49	2	24	48	1235
	Gris	001	-----							

Los pesos aquí reflejados pueden sufrir ligeras variaciones en función del lote de producción.
Weights shown here may slightly vary depending on the production lot.

COLORES / COLOURS

Esta colección dispone de acabado antideslizante.
Pacific Blanco Plus Non-slip 100 x 100 cm (20 / 10,5 mm) Clase 3 - R12 - A + B + C.
Consultar en la página 238.
A non-slip finishing is available for this collection.
Pacific Blanco Plus Non-slip 100 x 100 cm (20 / 10,5 mm) Class 3 - R12 - A + B + C.
Check on page 238.



Petra

Espesor / Thickness

- 20 mm
- 10,5 mm
- 6 mm**



Acabado / Finishing

- Natural / Natural**
- Abujardado / Bush-hammered**
- Non-slip**



PETRA 6 mm

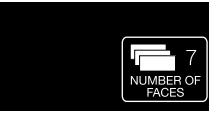

FORMATO FORMAT	COLOR COLOUR	ACABADO Y GRUPO DE PRECIO M ² FINISHING & PRICE GROUP SQM			PACKING					
		Natural Natural	Abujardado Bush-hammered	Non-slip	M ² Caja Box	Kg Caja Box	Piezas Caja Pieces Box	Cajas Palet Boxes Palet	M ² Palet Palet	Kg Palet Palet
150 x 300 cm 59" x 118 1/8" 	Crema	----	021	----	72*	1274*	16*	1*	72*	1274*
100 x 250 cm 39 3/8" x 98 3/8" 	Crema	114	----	----	50*	796*	20*	1*	50*	796*

Los pesos aquí reflejados pueden sufrir ligeras variaciones en función del lote de producción.
Weights shown here may slightly vary depending on the production lot.

*** 150 x 300 / 150 x 150 / 100 x 250 cm**

Los datos de packing corresponden a la venta de pallet completo; las cantidades inferiores tendrán un cargo correspondiente a los costes adicionales de manipulación y embalaje de estas piezas (140 €).
The packing data refers to the sale of a complete pallet; an additional charge will be applied to lower quantities to cover the costs of handling and packaging these items (140 €).

COLOR / COLOUR

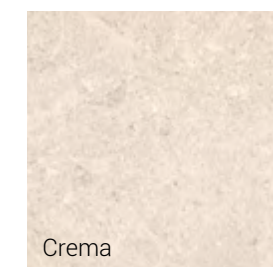

PETRA 20 mm

FORMATO FORMAT	COLOR COLOUR	ACABADO Y GRUPO DE PRECIO M ² FINISHING & PRICE GROUP SQM			PACKING					
		Natural Natural	Abujardado Bush-hammered	Non-slip	M ² Caja Box	Kg Caja Box	Piezas Caja Pieces Box	Cajas Palet Boxes Pallet	M ² Palet Pallet	Kg Palet Pallet
100 x 100 cm 39 3/8" x 39 3/8" 	Crema		----	306	1	50	1	24	24	1254,72

PETRA 10,5 mm

FORMATO FORMAT	COLOR COLOUR	ACABADO Y GRUPO DE PRECIO M ² FINISHING & PRICE GROUP SQM			PACKING					
		Natural Natural	Abujardado Bush-hammered	Non-slip	M ² Caja Box	Kg Caja Box	Piezas Caja Pieces Box	Cajas Palet Boxes Pallet	M ² Palet Pallet	Kg Palet Pallet
100 x 100 cm 39 3/8" x 39 3/8" 	Crema	001	----	001	2	49	2	24	48	1235

Los pesos aquí reflejados pueden sufrir ligeras variaciones en función del lote de producción.
Weights shown here may slightly vary depending on the production lot.

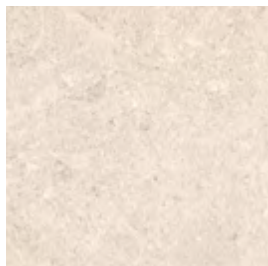
COLOR / COLOUR

Esta colección dispone de acabado antideslizante. Petra Crema Non-slip 100 x 100 cm (20 / 10,5 mm)
Clase 3 - R12 - A + B + C. Consultar en la página 238.
A non-slip finishing is available for this collection. Petra Crema Non-slip 100 x 100 cm (20 / 10,5 mm)
Class 3 - R12 - A + B + C. Check on page 238.



Rift

Espesor / Thickness



6 mm

Acabado / Finishing

Natural / Natural

RIFT 6 mm



FORMATO FORMAT	COLOR COLOUR	ACABADO Y GRUPO DE PRECIO M ² FINISHING & PRICE GROUP SQM	PACKING					
			M ² Caja Box	Kg Caja Box	Piezas Caja Pieces Box	Cajas Palet Boxes Palet	M ² Palet Palet	Kg Palet Palet
100 x 250 cm 39 3/8" x 98 3/8" 	Blanco	Natural Natural 114	50*	796*	20*	1*	50*	796*
100 x 100 cm 39 3/8" x 39 3/8" 	Blanco	Natural Natural 001	2	27,60	2	24	48	714

Los pesos aquí reflejados pueden sufrir ligeras variaciones en función del lote de producción.
Weights shown here may slightly vary depending on the production lot.

*** 100 x 250 cm**

Los datos de packing corresponden a la venta de pallet completo; las cantidades inferiores tendrán un cargo correspondiente a los costes adicionales de manipulación y embalaje de estas piezas (140 €).
The packing data refers to the sale of a complete pallet; an additional charge will be applied to lower quantities to cover the costs of handling and packaging these items (140 €).

COLOR / COLOUR

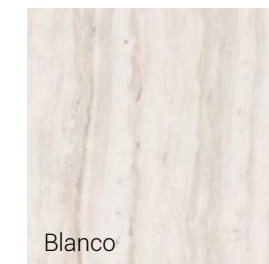

Blanco



Senda





Espesor / Thickness

6 mm

Acabado / Finishing

Natural / Natural

SENDA 6 mm

FORMATO FORMAT	COLOR COLOUR	ACABADO Y GRUPO DE PRECIO M ² FINISHING & PRICE GROUP SQM	PACKING					
			M ² Caja Box	Kg Caja Box	Piezas Caja Pieces Box	Cajas Palet Boxes Palet	M ² Palet Palet	Kg Palet Palet
150 x 300 cm 59" x 118 1/8" 	Gris	Natural Natural 021	72*	1274*	16*	1*	72*	1274*
150 x 150 cm 59" x 59" 	Gris	021	45*	725*	20*	1*	45*	725*
100 x 250 cm 39 3/8" x 98 3/8" 	Gris	114	50*	796*	20*	1*	50*	796*
100 x 100 cm 39 3/8" x 39 3/8" 	Gris	001	2	27,60	2	24	48	714

Los pesos aquí reflejados pueden sufrir ligeras variaciones en función del lote de producción.
Weights shown here may slightly vary depending on the production lot.

*** 150 x 300 / 150 x 150 / 100 x 250 cm**





Los datos de packing corresponden a la venta de pallet completo; las cantidades inferiores tendrán un cargo correspondiente a los costes adicionales de manipulación y embalaje de estas piezas (140 €).
The packing data refers to the sale of a complete pallet; an additional charge will be applied to lower quantities to cover the costs of handling and packaging these items (140 €).

COLOR / COLOUR





SILK 6 mm

FORMATO FORMAT	COLOR COLOUR	ACABADO Y GRUPO DE PRECIO M ² FINISHING & PRICE GROUP SQM		PACKING					
		Natural Natural	Abujardado Bush-hammered	M ² Caja Box	Kg Caja Box	Piezas Caja Pieces Box	Cajas Palet Boxes Palet	M ² Palet Palet	Kg Palet Palet
150 x 300 cm 59" x 118 1/8" 	Blanco		129	72*	1274*	16*	1*	72*	1274*
	Camel Visón Gris Negro		021						
150 x 150 cm 59" x 59" 	Blanco		129	45*	725*	20*	1*	45*	725*
	Camel Visón Gris Negro		021						
100 x 250 cm 39 3/8" x 98 3/8" 	Blanco		115	50*	796*	20*	1*	50*	796*
	Camel Visón Gris Negro		114						
100 x 100 cm 39 3/8" x 39 3/8" 	Blanco		122	2	27,60	2	24	48	714
	Camel Visón Gris Negro		001						

Los pesos aquí reflejados pueden sufrir ligeras variaciones en función del lote de producción.
Weights shown here may slightly vary depending on the production lot.

* 150 x 300 / 150 x 150 / 100 x 250 cm

Los datos de packing corresponden a la venta de pallet completo; las cantidades inferiores tendrán un cargo correspondiente a los costes adicionales de manipulación y embalaje de estas piezas (140 €).
The packing data refers to the sale of a complete pallet; an additional charge will be applied to lower quantities to cover the costs of handling and packaging these items (140 €).

COLORES / COLOURS

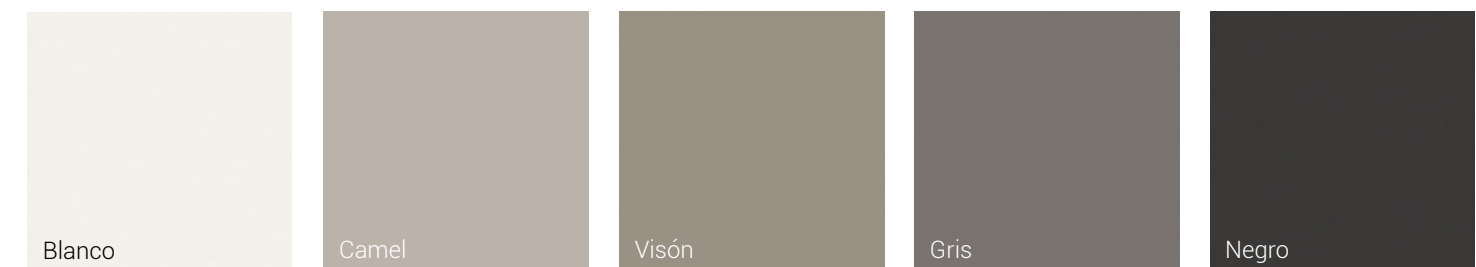

Silk

Espesor / Thickness



6 mm

Acabado / Finishing

Natural / Natural

Abujardado / Bush-hammered

SILK 6 mm

FORMATO FORMAT	COLOR COLOUR	ACABADO Y GRUPO DE PRECIO M ² FINISHING & PRICE GROUP SQM		PACKING					
		Natural Natural	Abujardado Bush-hammered	M ² Caja Box	Kg Caja Box	Piezas Caja Pieces Box	Cajas Palet Boxes Palet	M ² Palet Palet	Kg Palet Palet
20 x 20 cm 7 7/8" x 7 7/8" 	Blanco	307		1	14,20	25	96	96	1386
	Camel	194							
	Visón								
	Gris								
	Negro								
10 x 20 cm 3 7/8" x 7 7/8" 	Blanco	307		1	14,20	50	96	96	1386
	Camel	194							
	Visón								
	Gris								
	Negro								



Los pesos aquí reflejados pueden sufrir ligeras variaciones en función del lote de producción.
Weights shown here may slightly vary depending on the production lot.

COLORES / COLOURS





SOHO 6 mm

FORMATO FORMAT	COLOR COLOUR	ACABADO Y GRUPO DE PRECIO M ² FINISHING & PRICE GROUP SQM		PACKING					
		Abujardado Bush-hammered	Non-slip	M ² Caja Box	Kg Caja Box	Piezas Caja Pieces Box	Cajas Palet Boxes Palet	M ² Palet Palet	Kg Palet Palet
100 x 250 cm 39 3/8" x 98 3/8" 	Blanco	114	-----	50*	796*	20*	1*	50*	796*
100 x 100 cm 39 3/8" x 39 3/8" 	Blanco	001	-----	2	27,60	2	24	48	714

*** 100 x 250 cm**

Los datos de packing corresponden a la venta de pallet completo; las cantidades inferiores tendrán un cargo correspondiente a los costes adicionales de manipulación y embalaje de estas piezas (140 €).

The packing data refers to the sale of a complete pallet; an additional charge will be applied to lower quantities to cover the costs of handling and packaging these items (140 €).

SOHO 10,5 mm

FORMATO FORMAT	COLOR COLOUR	ACABADO Y GRUPO DE PRECIO M ² FINISHING & PRICE GROUP SQM		PACKING					
		Abujardado Bush-hammered	Non-slip	M ² Caja Box	Kg Caja Box	Piezas Caja Pieces Box	Cajas Palet Boxes Palet	M ² Palet Palet	Kg Palet Palet
100 x 100 cm 39 3/8" x 39 3/8" 	Blanco	-----	001	2	49	2	24	48	1235

Los pesos aquí reflejados pueden sufrir ligeras variaciones en función del lote de producción.
Weights shown here may slightly vary depending on the production lot.

COLOR / COLOUR

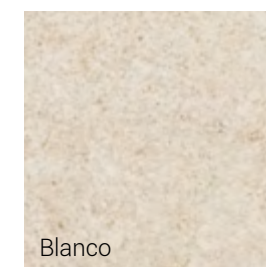

Esta colección dispone de acabado antideslizante. Soho Blanco Non-slip 100 x 100 cm (10,5 mm) Clase 3 - R12 - A + B + C. Consultar en la página 238.
A non-slip finishing is available for this collection. Soho Blanco Non-slip 100 x 100 cm (10,5 mm) Class 3 - R12 - A + B + C. Check on page 238.



Soho

Espesor / Thickness

10,5 mm

6 mm



Acabado / Finishing

Abujardado / Bush-hammered

Non-slip

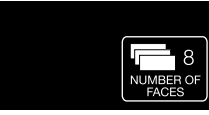

STORM 6 mm

FORMATO FORMAT	COLOR COLOUR	ACABADO Y GRUPO DE PRECIO M ² FINISHING & PRICE GROUP SQM		PACKING					
		Natural Natural	Pulido Brillo High-gloss Polished	M ² Caja Box	Kg Caja Box	Piezas Caja Pieces Box	Cajas Palet Boxes Palet	M ² Palet Palet	Kg Palet Palet
150 x 300 cm 59" x 118 1/8" 	Gris	021	152	72*	1274*	16*	1*	72*	1274*
	Negro								
150 x 150 cm 59" x 59" 	Gris	021	152	45*	725*	20*	1*	45*	725*
	Negro								
100 x 250 cm 39 3/8" x 98 3/8" 	Gris	114	153	50*	796*	20*	1*	50*	796*
	Negro								

Los pesos aquí reflejados pueden sufrir ligeras variaciones en función del lote de producción.
Weights shown here may slightly vary depending on the production lot.

*** 150 x 300 / 150 x 150 / 100 x 250 cm**

Los datos de packing corresponden a la venta de pallet completo; las cantidades inferiores tendrán un cargo correspondiente a los costes adicionales de manipulación y embalaje de estas piezas (140 €).
The packing data refers to the sale of a complete pallet; an additional charge will be applied to lower quantities to cover the costs of handling and packaging these items (140 €).

COLORES / COLOURS



Gris

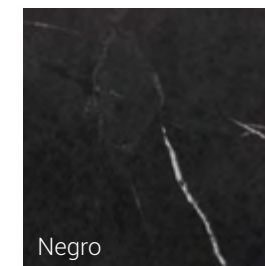

Negro



Storm

Espesor / Thickness

10,5 mm

6 mm

Acabado / Finishing

Natural / Natural

Pulido Brillo / High-gloss Polished

STORM 6 mm

FORMATO FORMAT	COLOR COLOUR	ACABADO Y GRUPO DE PRECIO M ² FINISHING & PRICE GROUP SQM		PACKING					
		Natural Natural	Pulido Brillo High-gloss Polished	M ² Caja Box	Kg Caja Box	Piezas Caja Pieces Box	Cajas Palet Boxes Pallet	M ² Palet Pallet	Kg Palet Pallet
100 x 100 cm 39 3/8" x 39 3/8" 	Gris	001	154	2	27,60	2	24	48	714
	Negro								

STORM 10,5 mm

FORMATO FORMAT	COLOR COLOUR	ACABADO Y GRUPO DE PRECIO M ² FINISHING & PRICE GROUP SQM		PACKING					
		Natural Natural	Pulido Brillo High-gloss Polished	M ² Caja Box	Kg Caja Box	Piezas Caja Pieces Box	Cajas Palet Boxes Pallet	M ² Palet Pallet	Kg Palet Pallet
100 x 100 cm 39 3/8" x 39 3/8" 	Gris	001	-----	2	49	2	24	48	1235
	Negro								

Los pesos aquí reflejados pueden sufrir ligeras variaciones en función del lote de producción.
Weights shown here may slightly vary depending on the production lot.

COLORES / COLOURS

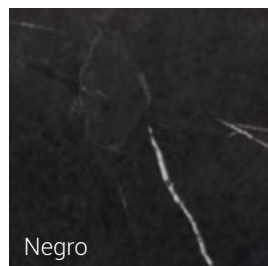



Syros





Espesor / Thickness
6 mm

Acabado / Finishing
Natural / Natural
Pulido Mate / Matt Polished

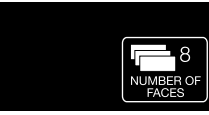

SYROS 6 mm



FORMATO FORMAT	COLOR COLOUR	ACABADO Y GRUPO DE PRECIO M ² FINISHING & PRICE GROUP SQM		PACKING					
		Natural Natural	Pulido Mate Matt Polished	M2 Caja Box	Kg Caja Box	Piezas Caja Pieces Box	Cajas Palet Boxes Pallet	M2 Palet Pallet	Kg Palet Pallet
150 x 300 cm 59" x 118 1/8" 	Super Blanco-Gris	129	162	72*	1274*	16*	1*	72*	1274*
150 x 150 cm 59" x 59" 	Super Blanco-Gris	129	----	45*	725*	20*	1*	45*	725*
100 x 250 cm 39 3/8" x 98 3/8" 	Super Blanco-Gris	115	164	50*	796*	20*	1*	50*	796*
100 x 100 cm 39 3/8" x 39 3/8" 	Super Blanco-Gris	122	----	2	27,60	2	24	48	714

Los pesos aquí reflejados pueden sufrir ligeras variaciones en función del lote de producción.
Weights shown here may slightly vary depending on the production lot.

*** 150 x 300 / 150 x 150 / 100 x 250 cm**

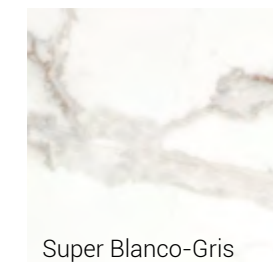

Los datos de packing corresponden a la venta de pallet completo; las cantidades inferiores tendrán un cargo correspondiente a los costes adicionales de manipulación y embalaje de estas piezas (140 €).
The packing data refers to the sale of a complete pallet; an additional charge will be applied to lower quantities to cover the costs of handling and packaging these items (140 €).

COLOR / COLOUR





THE NEW BLACKS 6 mm

FORMATO FORMAT	COLOR COLOUR	ACABADO Y GRUPO DE PRECIO M ² FINISHING & PRICE GROUP SQM	PACKING					
			M ² Caja Box	Kg Caja Box	Piezas Caja Pieces Box	Cajas Palet Boxes Palet	M ² Palet Palet	Kg Palet Palet
100 x 250 cm 39 3/8" x 98 3/8" 	Natural Natural							
	Amaranto	305	50*	796*	20*	1*	50*	796*
	Castagna							
	Muschio							
Prugna								
20 x 20 cm 7 7/8" x 7 7/8" 	Amaranto	308	1	14,20	25	96	96	1386
	Castagna							
	Muschio							
	Prugna							
10 x 20 cm 3 7/8" x 7 7/8" 	Amaranto	308	1	14,20	50	96	96	1386
	Castagna							
	Muschio							
	Prugna							

Los pesos aquí reflejados pueden sufrir ligeras variaciones en función del lote de producción.
Weights shown here may slightly vary depending on the production lot.

*** 100 x 250 cm**

Los datos de packing corresponden a la venta de pallet completo; las cantidades inferiores tendrán un cargo correspondiente a los costes adicionales de manipulación y embalaje de estas piezas (140 €).
The packing data refers to the sale of a complete pallet; an additional charge will be applied to lower quantities to cover the costs of handling and packaging these items (140 €).



The New Blacks

Espesor / Thickness

6 mm

Acabado / Finishing

Natural / Natural

COLORES / COLOURS

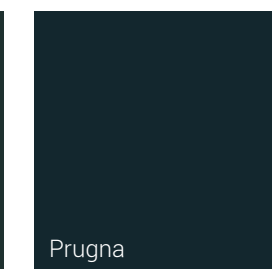
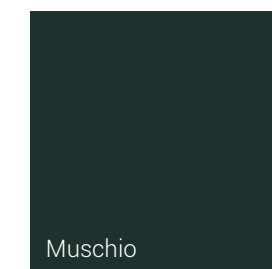
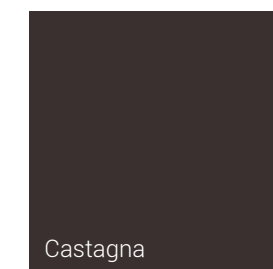
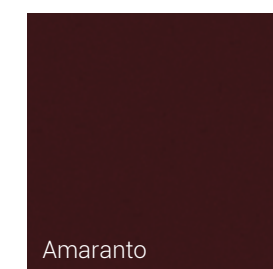



Touché

Espesor / Thickness

10,5 mm

6 mm

Acabado / Finishing

Natural / Natural



Abujardado / Bush-hammered

Pulido Brillo / High-gloss Polished



TOUCHÉ 6 mm



FORMATO FORMAT	COLOR COLOUR	ACABADO Y GRUPO DE PRECIO M ² FINISHING & PRICE GROUP SQM			PACKING					
		Natural Natural	Abujardado Bush-hammered	Pulido Brillo High-gloss Polished	M ² Caja Box	Kg Caja Box	Piezas Caja Pieces Box	Cajas Palet Boxes Palet	M ² Palet Palet	Kg Palet Palet
150 x 300 cm 59" x 118 1/8" 	Super Blanco-Gris	129	-----	121	72*	1274*	16*	1*	72*	1274*
150 x 150 cm 59" x 59" 	Super Blanco-Gris	129	-----	121	45*	725*	20*	1*	45*	725*
100 x 250 cm 39 3/8" x 98 3/8" 	Super Blanco-Gris	115		116	50*	796*	20*	1*	50*	796*

Los pesos aquí reflejados pueden sufrir ligeras variaciones en función del lote de producción.
Weights shown here may slightly vary depending on the production lot.

*** 150 x 300 / 150 x 150 / 100 x 250 cm**

Los datos de packing corresponden a la venta de pallet completo; las cantidades inferiores tendrán un cargo correspondiente a los costes adicionales de manipulación y embalaje de estas piezas (140 €).
The packing data refers to the sale of a complete pallet; an additional charge will be applied to lower quantities to cover the costs of handling and packaging these items (140 €).

COLOR / COLOUR

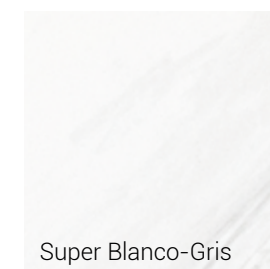

Super Blanco-Gris



TOUCHÉ (BOOKMATCH) 6 mm SLIMM

FORMATO FORMAT	COLOR COLOUR	ACABADO Y GRUPO DE PRECIO M ² FINISHING & PRICE GROUP SQM			PACKING					
		Natural Natural	Abujardado Bush-hammered	Pulido Brillo High-gloss Polished	M ² Caja Box	Kg Caja Box	Piezas Caja Pieces Box	Cajas Palet Boxes Pallet	M ² Palet Pallet	Kg Palet Pallet
150 x 300 cm 59" x 118 1/8"	Super Blanco-Gris A	144	-----	145	72*	1274*	16*	1*	72*	1274*
	Super Blanco-Gris B									
100 x 250 cm 39 3/8" x 98 3/8"	Super Blanco-Gris A	142	-----	143	50*	796*	20*	1*	50*	796*
	Super Blanco-Gris B									

*** 150 x 300 / 100 x 250 cm**

Los datos de packing corresponden a la venta de pallet completo; las cantidades inferiores tendrán un cargo correspondiente a los costes adicionales de manipulación y embalaje de estas piezas (140 €).

The packing data refers to the sale of a complete pallet; an additional charge will be applied to lower quantities to cover the costs of handling and packaging these items (140 €).

Los formatos 150 x 300 y 100 x 250 cm de la colección Touché en los acabados Natural y Pulido Brillo permite la colocación bookmatch o efecto espejo. Para conseguir este efecto, se colocan piezas A y B del mismo color y acabado. Por ejemplo: Super Blanco-Gris A Pulido Brillo y Super Blanco-Gris B Pulido Brillo. Touché Series in a 150 x 300 and 100 x 250 cm formats and Natural and High-gloss Polished finishings can be used to create a bookmatching mirror effect. To achieve this effect, A + B references with the same colour and finishing must be used. For example: Super Blanco-Gris A High-gloss Polished and Super Blanco-Gris B High-gloss Polished.

TOUCHÉ BOOKMATCH VERTICAL 150x300 cm

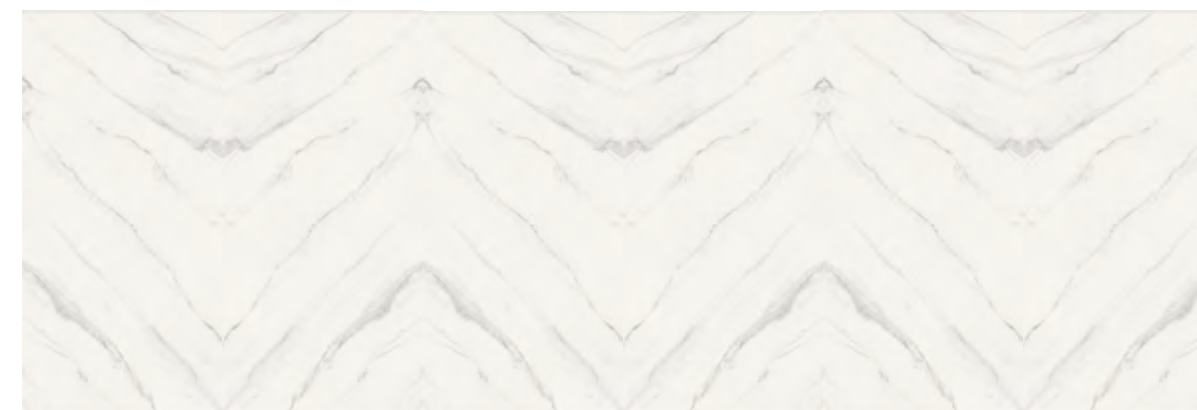

Super Blanco-Gris A Super Blanco-Gris B Super Blanco-Gris A Super Blanco-Gris B Super Blanco-Gris A Super Blanco-Gris B

TOUCHÉ BOOKMATCH HORIZONTAL 150x300 cm

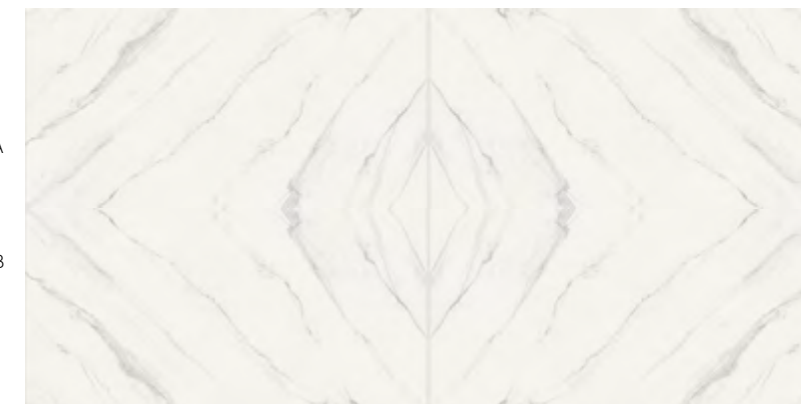

Super Blanco-Gris A Super Blanco-Gris B Super Blanco-Gris A Super Blanco-Gris B

TOUCHÉ BOOKMATCH VERTICAL 100x250 cm

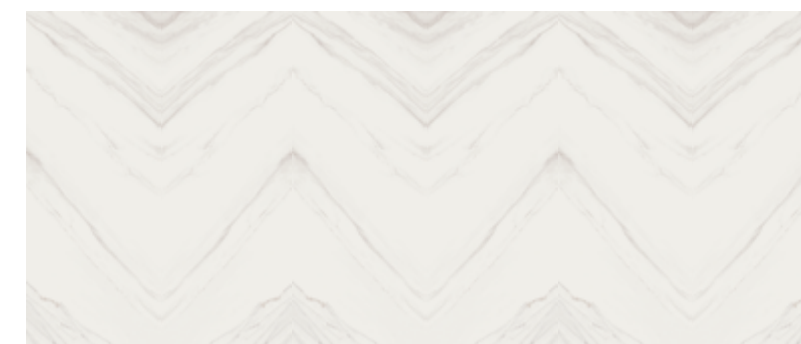

Super Blanco-Gris A Super Blanco-Gris B Super Blanco-Gris A Super Blanco-Gris B Super Blanco-Gris A Super Blanco-Gris B

TOUCHÉ BOOKMATCH HORIZONTAL 100x250 cm

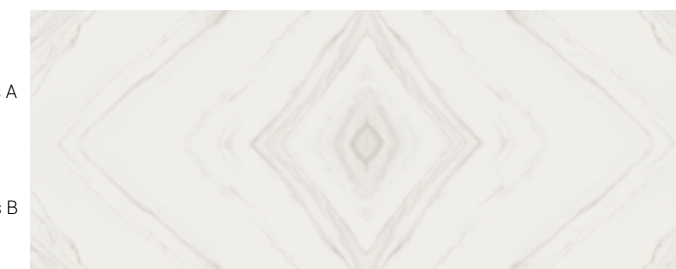

Super Blanco-Gris A Super Blanco-Gris B Super Blanco-Gris A Super Blanco-Gris B



TOUCHÉ 10,5 mm

FORMATO FORMAT	COLOR COLOUR	ACABADO Y GRUPO DE PRECIO M ² FINISHING & PRICE GROUP SQM			PACKING					
		Natural Natural	Abujardado Bush-hammered	Pulido Brillo High-gloss Polished	M ² Caja Box	Kg Caja Box	Piezas Caja Pieces Box	Cajas Palet Boxes Pallet	M ² Palet Pallet	Kg Palet Pallet
100 x 100 cm 39 3/8" x 39 3/8" 	Super Blanco-Gris		122	128	2	49	2	24	48	1235



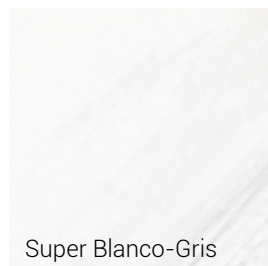

Los pesos aquí reflejados pueden sufrir ligeras variaciones en función del lote de producción.
Weights shown here may slightly vary depending on the production lot.

COLOUR / COLOUR





UMBRA 6 mm

FORMATO FORMAT	COLOR COLOUR	ACABADO Y GRUPO DE PRECIO M ² FINISHING & PRICE GROUP SQM		PACKING					
		Abujardado Bush-hammered	Non-slip	M ² Caja Box	Kg Caja Box	Piezas Caja Pieces Box	Cajas Palet Boxes Palet	M ² Palet Palet	Kg Palet Palet
150 x 300 cm 59" x 118 1/8" 	Marrón	021	----	72*	1274*	16*	1*	72*	1274*
150 x 150 cm 59" x 59" 	Marrón	021	----	45*	725*	20*	1*	45*	725*
100 x 250 cm 39 3/8" x 98 3/8" 	Marrón	114	----	50*	796*	20*	1*	50*	796*
100 x 100 cm 39 3/8" x 39 3/8" 	Marrón	001	----	2	27,60	2	24	48	714

Los pesos aquí reflejados pueden sufrir ligeras variaciones en función del lote de producción.
Weights shown here may slightly vary depending on the production lot.

*** 150 x 300 / 150 x 150 / 100 x 250 cm**

Los datos de packing corresponden a la venta de pallet completo; las cantidades inferiores tendrán un cargo correspondiente a los costes adicionales de manipulación y embalaje de estas piezas (140 €).
The packing data refers to the sale of a complete pallet; an additional charge will be applied to lower quantities to cover the costs of handling and packaging these items (140 €).

COLOR / COLOUR



Umbra

Espesor / Thickness

20 mm

6 mm

Acabado / Finishing



Abujardado / Bush-hammered

Non-slip



UMBRA 6 mm



FORMATO FORMAT	COLOR COLOUR	ACABADO Y GRUPO DE PRECIO M ² FINISHING & PRICE GROUP SQM		PACKING					
		Abujardado Bush-hammered	Non-slip	M ² Caja Box	Kg Caja Box	Piezas Caja Pieces Box	Cajas Palet Boxes Pallet	M ² Palet Pallet	Kg Palet Pallet
25 x 19,5 cm 9 3/4" x 7 3/4" 	Marrón	193	----	0,83	11,50	25	96	79,68	1125
20 x 20 cm 7 7/8" x 7 7/8" 	Marrón	194	----	1	14,20	25	96	96	1386
10 x 20 cm 3 7/8" x 7 7/8" 	Marrón	194	----	1	14,20	50	96	96	1386

Los pesos aquí reflejados pueden sufrir ligeras variaciones en función del lote de producción.
Weights shown here may slightly vary depending on the production lot.

UMBRA 20 mm

FORMATO FORMAT	COLOR COLOUR	ACABADO Y GRUPO DE PRECIO M ² FINISHING & PRICE GROUP SQM		PACKING					
		Abujardado Bush-hammered	Non-slip	M ² Caja Box	Kg Caja Box	Piezas Caja Pieces Box	Cajas Palet Boxes Pallet	M ² Palet Pallet	Kg Palet Pallet
20 x 30 cm 7 7/8" x 11 3/4" 	Marrón	----	195	0,24	11,16	4	128	30,72	1360
20 x 20 cm 7 7/8" x 7 7/8" 	Marrón	----	195	0,24	11,17	6	120	28,80	1361

Los pesos aquí reflejados pueden sufrir ligeras variaciones en función del lote de producción.
Weights shown here may slightly vary depending on the production lot.

COLOR / COLOUR



Esta colección dispone de acabado antideslizante. Umbra Marrón Non-slip 20 x 30 / 20 x 20 cm (20 mm)
Clase 3 - R12 - A + B + C. Consultar en la página 238.
A non-slip finishing is available for this collection. Umbra Marrón Non-slip 20 x 30 / 20 x 20 cm (20 mm)
Class 3 - R12 - A + B + C. Check on page 238.



Vint

Espesor / Thickness

6 mm

Acabado / Finishing

Natural / Natural

Abujardado / Bush-hammered

VINT 6 mm

FORMATO FORMAT	COLOR COLOUR	ACABADO Y GRUPO DE PRECIO M ² FINISHING & PRICE GROUP SQM		PACKING					
		Natural Natural	Abujardado Bush-hammered	M ² Caja Box	Kg Caja Box	Piezas Caja Pieces Box	Cajas Palet Boxes Palet	M ² Palet Palet	Kg Palet Palet
150 x 300 cm 59" x 118 1/8"	Gris	021	----	72*	1274*	16*	1*	72*	1274*
	Deco Gris	----							
150 x 150 cm 59" x 59"	Gris	021	----	45*	725*	20*	1*	45*	725*
	Deco Gris	----							
100 x 250 cm 39 3/8" x 98 3/8"	Gris	114	----	50*	796*	20*	1*	50*	796*
	Deco Gris	----	114						
100 x 100 cm 39 3/8" x 39 3/8"	Gris	001		2	27,60	2	24	48	714
	Deco Gris	----							

Los pesos aquí reflejados pueden sufrir ligeras variaciones en función del lote de producción.
Weights shown here may slightly vary depending on the production lot.



*** 150 x 300 / 150 x 150 / 100 x 250 cm**

Los datos de packing corresponden a la venta de pallet completo; las cantidades inferiores tendrán un cargo correspondiente a los costes adicionales de manipulación y embalaje de estas piezas (140 €).
The packing data refers to the sale of a complete pallet; an additional charge will be applied to lower quantities to cover the costs of handling and packaging these items (140 €).

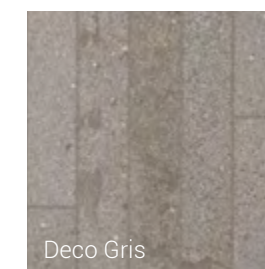
COLORES / COLOURS



VINT 6 mm

FORMATO FORMAT	COLOR COLOUR	ACABADO Y GRUPO DE PRECIO M ² FINISHING & PRICE GROUP SQM		PACKING					
		Natural Natural	Abujardado Bush-hammered	M ² Caja Box	Kg Caja Box	Piezas Caja Pieces Box	Cajas Palet Boxes Pallet	M ² Palet Pallet	Kg Palet Pallet
25 x 19,5 cm 9 3/4" x 7 3/4" 	Gris	193	----	0,83	11,50	25	96	79,68	1125
20 x 20 cm 7 7/8" x 7 7/8" 	Gris	194	----	1	14,20	25	96	96	1386
10 x 20 cm 3 7/8" x 7 7/8" 	Gris	194	----	1	14,20	50	96	96	1386

Los pesos aquí reflejados pueden sufrir ligeras variaciones en función del lote de producción.
Weights shown here may slightly vary depending on the production lot.

COLOR / COLOUR

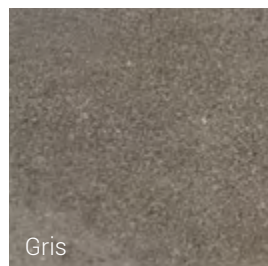



PREMIUM 75 x 150 cm

75 x 150 cm / 29 1/2" x 59" (11 mm)

SERIE SERIES	COLOR COLOUR	ACABADO Y GRUPO DE PRECIO M ² FINISHING & PRICE GROUP SQM	PACKING					
			M ² Caja Box	Kg Caja Box	Piezas Caja Pieces Box	Cajas Palet Boxes Pallet	M ² Palet Pallet	Kg Palet Pallet
VOSS	Blanco-Gris	Natural Natural 155	1,13	29,25	1	36	40,68	1082

Los pesos aquí reflejados pueden sufrir ligeras variaciones en función del lote de producción.
Weights shown here may slightly vary depending on the production lot.



CERAMIC PORCELAIN TILES

COLOR / COLOUR

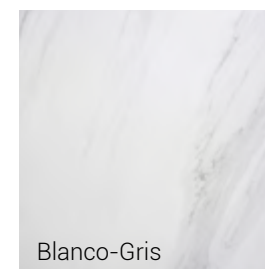

Blanco-Gris



COMPLEMENTOS
COMPLEMENTS



ENMALLADOS / MESH-MOUNTED PIECES

ENMALLADOS / MESH-MOUNTED PIECES

BLANCO	CREMA	PIEDRA	MOKA
 <p>ICE Super Blanco Natural / Natural</p> <p>6 mm</p>			
 <p>MASAI Blanco Plus Abujardado / Bush-hammered</p> <p>6 mm</p>	 <p>PETRA*** Crema Natural / Natural</p> <p>10,5 mm</p>	 <p>MASAI Piedra Abujardado / Bush-hammered</p> <p>6 mm</p>	 <p>JASPER Moka Abujardado / Bush-hammered</p> <p>6 mm</p>

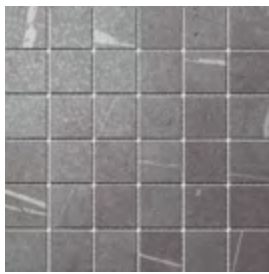
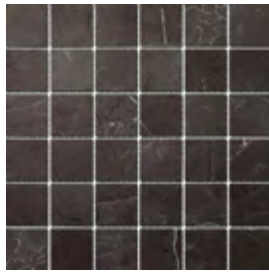
GRIS	NEGRO
 <p>ISEO Gris Abujardado / Bush-hammered</p> <p>6 mm</p>	 <p>SENDA Gris Natural / Natural</p> <p>6 mm</p>
 <p>STORM Negro Natural / Natural</p> <p>6 mm</p>	

6 mm   SLIMM

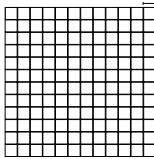
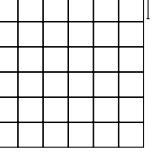
FORMATO FORMAT	GRUPO DE PRECIO M ² PRICE GROUP SQM	PACKING					
		M ² Caja Box	Kg Caja Box	Piezas Caja Pieces Box	Cajas Palet Boxes Palet	M ² Palet Palet	Kg Palet Palet
<p>30 x 30 cm 11 3/4" x 11 3/4"</p> <p>2,5 cm / 1" 2,5 cm / 1"</p> 	091	1,26	10,85	14	36	45,36	410,60
<p>30 x 30 cm 11 3/4" x 11 3/4"</p> <p>5 cm / 2" 5 cm / 2"</p> 	081	1,26	14,50	14	36	45,46	522

*** 10,5 mm  

FORMATO FORMAT	GRUPO DE PRECIO M ² PRICE GROUP SQM	PACKING					
		M ² Caja Box	Kg Caja Box	Piezas Caja Pieces Box	Cajas Palet Boxes Palet	M ² Palet Palet	Kg Palet Palet
<p>30 x 30 cm 11 3/4" x 11 3/4"</p> <p>5 cm / 2" 5 cm / 2"</p> 	081	0,81	18,72	9	36	29,16	674

RODAPIÉS Y PELDAÑOS / SKIRTINGS AND STEPS

RODAPIÉS Y PELDAÑOS / SKIRTINGS AND STEPS

INALCO SSC

ES

INALCO SSC es el servicio personalizado que Inalco ofrece a todos sus partners y clientes para responder a las necesidades específicas de cada proyecto de una forma rápida y efectiva.

Contactando directamente con el departamento comercial de Inalco podrá obtener respuestas concretas de pedidos, precios, personalización de producto y especificaciones técnicas.

Los productos referenciados bajo la etiqueta INALCO SSC serán fabricados y comercializados bajo pedido y presupuesto previo.

EN

INALCO SSC is the customized service that Inalco offers its partners and customers to meet the specific needs of each project quickly and effectively.

Though our Sales Department you can get particular answers about orders, prices, product customization and technical specifications.

The products under the label INALCO SSC will be manufactured and sold on demand and with a previous budget.

FR

INALCO SSC est le service spécial personnalisé qu'offre INALCO à tous ces partenaires et clients afin de répondre aux nécessités spécifiques de chaque projet et de manière rapide et efficace.

En contactant directement le département commercial d'Inalco, vous pourrez obtenir des réponses concrètes pour vos commandes, vos prix, la personnalisation de produits et les spécifications techniques.

Les produits référencés sous la dénomination INALCO SSC seront fabriqués et commercialisés uniquement sur devis et commande.

DE

INALCO SSC ist der personalisierte Service, den die Firma Inalco allen Partnern und Kunden bietet, um schnell und effizient auf die speziellen Bedürfnisse jedes Projekts reagieren zu können.

Wenn Sie sich direkt mit der Vertriebsabteilung von Inalco in Verbindung setzen, erhalten Sie konkrete Antworten zu Bestellungen, Preisen, Produktpersonalisierung und technischen Spezifikationen.

Alle Produkte, die mit der Marke INALCO SSC vertrieben werden, werden auf Bestellung und nach Kostenvoranschlag hergestellt und kommerzialisiert.

IT

INALCO SSC è il servizio personalizzato che Inalco offre a tutti i propri partner e clienti per soddisfare con rapidità ed efficacia le esigenze specifiche di ogni progetto.

Contattando direttamente l'ufficio commerciale di Inalco è possibile ottenere risposte precise riguardo a ordini, prezzi, personalizzazione del prodotto e specifiche tecniche.

I prodotti recanti l'etichetta INALCO SSC saranno realizzati e venduti su ordinazione e approvazione del preventivo.

RU

INALCO SSC — это персонализированное обслуживание, которое компания Inalco предлагает всем своим партнерам и клиентам. Оно позволяет быстро и эффективно обеспечивать нужные решения для специфических потребностей каждого проекта.

Обратившись напрямую в коммерческий отдел Inalco, вы сможете получить конкретные ответы, касающиеся заказов, цен, персонализации продуктов и технических спецификаций.

Продукты, имеющие этикетку INALCO SSC, выпускаются и продаются по заказу с предварительной сметой.

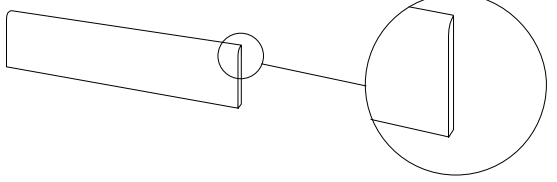
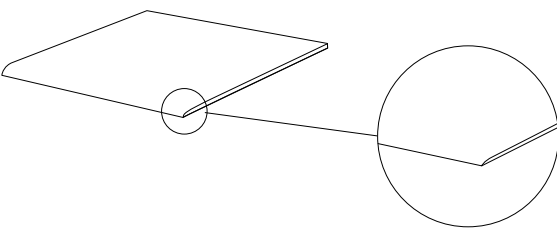
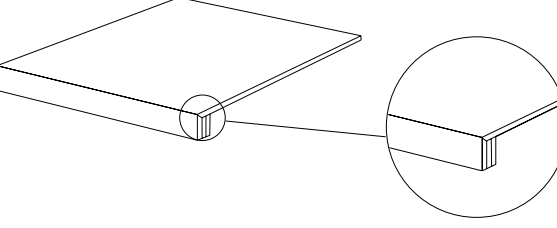
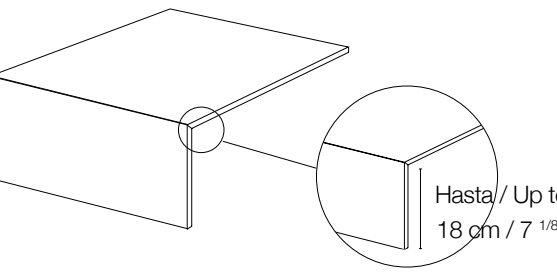
6 mm		SUMM			
TIPO DE PIEZA TYPE OF PIECE	GRUPO DE PRECIO M ² PRICE GROUP SQM	PACKING			
		M ² Caja Box	Kg Caja Box	Piezas Caja Pieces Box	
 <p>RODAPIÉ SKIRTING</p>	9,5 x 100 cm 3 3/4" x 39 3/8" Consultar disponibilidad en página 235 Check availability on page 235	222	1,43	16,35	15
 <p>PELDAÑO ROMO ROUNDED-EDGE STEP</p>	100 x 100 cm 39 3/8" x 39 3/8"	INALCO SSC	1,00	14,13	1
 <p>PELDAÑO TÉCNICO INGLETADO MITRED-EDGE TECHNICAL STEP</p>	100 x 100 cm 39 3/8" x 39 3/8"	INALCO SSC	1,00	15,13	1
 <p>PELDAÑO TÉCNICO INGLETADO METÁLICO MITRED-EDGE TECHNICAL STEP (METAL)</p>	100 x 100 cm 39 3/8" x 39 3/8" Hasta / Up to 18 cm / 7 1/8"	INALCO SSC	1,18	16,70	1

RODAPIÉS Y PELDAÑOS / SKIRTINGS AND STEPS

COMPLEMENTOS: RODAPIÉS DISPONIBLES
COMPLEMENTS: AVAILABLE SKIRTINGS

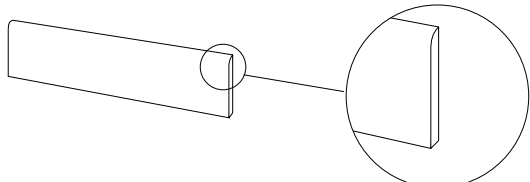
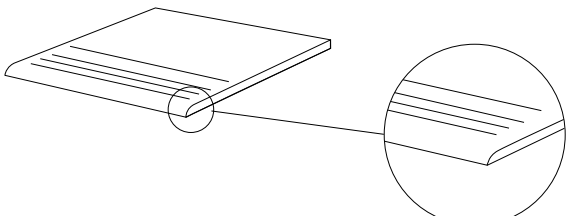
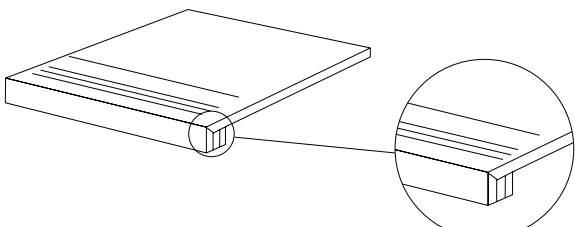
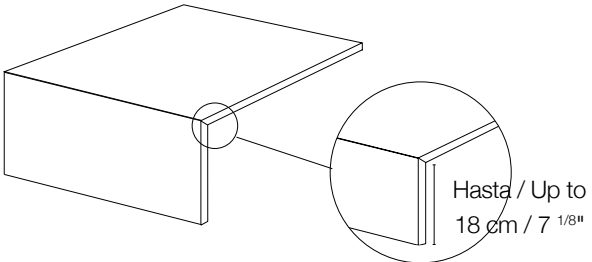
10,5 mm					
TIPO DE PIEZA TYPE OF PIECE	GRUPO DE PRECIO M ² PRICE GROUP SQM	PACKING			
		MP Caja Box	Kg Caja Box	Piezas Caja Pieces Box	
 <p>RODAPIÉ SKIRTING</p>	9,5 x 100 cm 3 3/4" x 39 3/8" Consultar disponibilidad en página 235 Check availability on page 235	222	0,57	17,00	6
 <p>PELDAÑO ROMO ROUNDED-EDGE STEP</p>	100 x 100 cm 39 3/8" x 39 3/8"	INALCO SSC	1,00	26,60	1
 <p>PELDAÑO TÉCNICO INGLETADO MITRED-EDGE TECHNICAL STEP</p>	100 x 100 cm 39 3/8" x 39 3/8"	INALCO SSC	1,00	26,60	1
 <p>PELDAÑO TÉCNICO INGLETADO METÁLICO MITRED-EDGE TECHNICAL STEP (METAL)</p>	100 x 100 cm 39 3/8" x 39 3/8" Hasta / Up to 18 cm / 7 1/8"	INALCO SSC	1,18	29,00	1

SERIES	9,5 x 100 cm 10,5 mm		9,5 x 100 cm 6 mm	
	ACABADO / FINISHING		ACABADO / FINISHING	
	Natural Natural	Abujardado Bush-hammered	Natural Natural	Abujardado Bush-hammered
ALEA			✓	
ANTAL		✓		
ASTRAL			✓	
AZALAI			✓	
FLUORITE			✓	
GEO				✓
GROUND			✓	
ICE			✓	
ISEO		✓		
JASPER		✓		
JOY	✓			
LARSEN			✓	
MASAI		✓		
METEORA				✓
MOON				✓
PACIFIC	✓			
PETRA	✓			
RIFT			✓	
SENDA			✓	
SILK			✓	
SOHO				✓
STORM	✓			
SYROS			✓	
TOUCHÉ	✓			
UMBRA				✓
VINT			✓	



INFORMACIÓN TÉCNICA
TECHNICAL INFORMATION



PRODUCTO ANTIDESLIZANTE: CLASE 3 - R12 - A+B+C NON-SLIP PRODUCT: CLASS 3 - R12 - A+B+C

Los acabados antideslizantes de INALCO combinan diseño con las máximas prestaciones técnicas, necesarias en los proyectos más exigentes.

Los pavimentos antideslizantes de INALCO incorporan las cualidades óptimas para ser colocados en zonas húmedas, terrazas, escaleras exteriores y bordes de piscina, entre otros.

Aúnan diseños y texturas elegantes y actuales, permitiendo la creación de espacios exteriores en tendencia, con unas características técnicas excepcionales: resisten altas y bajas temperaturas, cuentan con una absorción de humedad prácticamente nula, son resistentes y fáciles de limpiar.

Todos los pavimentos antideslizantes de INALCO cumplen y superan las principales normativas internacionales en material de seguridad de antideslizamiento (CLASE 3 / A+B+C / R12).

INALCO 's non-slip finishings combine design appeal with the high technical performance required for more demanding projects.

INALCO's non-slip floor surfaces feature ultimate characteristics, making them ideal for use in wet areas and outdoor ones, like terraces, exterior staircases and swimming pools, among others.

The collections are also conspicuous for their elegant modern designs, allowing for the creation of trendy outdoor spaces, and stand out for their outstanding technical features: They withstand sharp temperature changes, have almost nil water absorption, are highly resistant and easy to clean and care for.

INALCO's non-slip floor surfaces meet and exceed the slip resistance safety requirements of leading international standards (CLASS 3 / A+B+C / R12).

PRODUCTO PRODUCT	FORMATO FORMAT	ESPESOR THICKNESS	PACKING					
			M ² Caja Box	Kg Caja Box	Piezas Caja Pieces Box	Cajas Palet Boxes Palet	M ² Palet Palet	Kg Palet Palet
ISEO GRIS NON-SLIP	100 x 100 cm	10,5 mm	2	49	2	24	48	1235
JASPER MOKA NON-SLIP								
MASAI BLANCO PLUS NON-SLIP								
METEORA GRIS NON-SLIP								
PACIFIC BLANCO PLUS NON-SLIP								
PETRA CREMA NON SLIP								
SOHO BLANCO NON-SLIP								
PACIFIC BLANCO PLUS NON-SLIP	100 x 100 cm	20 mm	1	50	1	24	24	1254,72
PETRA CREMA NON SLIP								
MOON GRIS NON-SLIP	20 x 30	20 mm	0,24	11,16	4	128	30,72	1360
UMBRA MARRÓN NON-SLIP								
MOON GRIS NON-SLIP	20 x 20	20 mm	0,24	11,17	6	120	26,80	1361
UMBRA MARRÓN NON-SLIP								

NORMA / NORM ASTM-C 1028 COF	NORMA / NORM ANSI A 137.1 DCOF	NORMA / NORM UNE-ENV 12633	NORMA / NORM DIN 51130	NORMA / NORM DIN 51097
> 0,6 Seco y húmedo / Dry and wet	> 0,42 Seco y húmedo / Dry and wet	CLASE 3* (Resultados / Results > 65)	R12*	A+B+C*

* Los productos antideslizantes de INALCO obtienen resultados muy superiores a los valores máximos exigidos en las normas internacionales de antideslizamiento.

* INALCO's non-slip products highly exceed the maximum slip resistance safety requirements of leading international standards.

VALORES DE ANTIDESLIZAMIENTO PRODUCTO INALCO NON-SLIP VALUES INALCO PRODUCTS

COLECCIÓN COLLECTION	NORMA / NORM ASTM-C 1028-96: COF	NORMA / NORM ANSI A 137.1: 2012 DCOF	NORMA / NORM UNE-ENV 12633	NORMA / NORM DIN 51130	NORMA / NORM DIN 51097
ALEA Natural / Natural	> 0,6 Seco y húmedo / Dry and wet	> 0,42 Seco y húmedo / Dry and wet	CLASE 1	R9	A
ANANDA Arenado / Arenado	> 0,6 Seco y húmedo / Dry and wet	> 0,42 Seco y húmedo / Dry and wet	CLASE 2	R10	A+B
ANTAL Abujardado / Bush-hammered	> 0,6 Seco y húmedo / Dry and wet	> 0,42 Seco y húmedo / Dry and wet	CLASE 2	R10	A+B
ARIZONA Natural / Natural	> 0,6 Seco y húmedo / Dry and wet	> 0,42 Seco y húmedo / Dry and wet	CLASE 1	R9	A
ASTRAL Natural / Natural	> 0,6 Seco y húmedo / Dry and wet	> 0,42 Seco y húmedo / Dry and wet	CLASE 1	R9	A
AZALAI Natural / Natural	> 0,6 Seco y húmedo / Dry and wet	> 0,42 Seco y húmedo / Dry and wet	CLASE 1	R9	A
BOSCO Natural / Natural	> 0,6 Seco y húmedo / Dry and wet	> 0,42 Seco y húmedo / Dry and wet	CLASE 1	R9	A
FLUORITE Natural / Natural	> 0,6 Seco y húmedo / Dry and wet	> 0,42 Seco y húmedo / Dry and wet	CLASE 1	R9	A
FUSION Natural / Natural	> 0,6 Seco y húmedo / Dry and wet	> 0,42 Seco y húmedo / Dry and wet	CLASE 1	R9	A
GEO Abujardado / Bush-hammered	> 0,6 Seco y húmedo / Dry and wet	> 0,42 Seco y húmedo / Dry and wet	CLASE 2	R10	A+B
GROUND Natural / Natural	> 0,6 Seco y húmedo / Dry and wet	> 0,42 Seco y húmedo / Dry and wet	CLASE 1	R9	A
ICE Natural / Natural	> 0,6 Seco y húmedo / Dry and wet	> 0,42 Seco y húmedo / Dry and wet	CLASE 1	R9	A
ISEO Abujardado / Bush-hammered	> 0,6 Seco y húmedo / Dry and wet	> 0,42 Seco y húmedo / Dry and wet	CLASE 2	R10	A+B
ISEO Non-Slip	> 0,6 Seco y húmedo / Dry and wet	> 0,42 Seco y húmedo / Dry and wet	CLASE 3	R12	A+B+C
JASPER Abujardado / Bush-hammered	> 0,6 Seco y húmedo / Dry and wet	> 0,42 Seco y húmedo / Dry and wet	CLASE 2	R10	A+B
JASPER Non-Slip	> 0,6 Seco y húmedo / Dry and wet	> 0,42 Seco y húmedo / Dry and wet	CLASE 3	R12	A+B+C
JOY Natural / Natural	> 0,6 Seco y húmedo / Dry and wet	> 0,42 Seco y húmedo / Dry and wet	CLASE 1	R9	A
LARSEN Natural / Natural	> 0,6 Seco y húmedo / Dry and wet	> 0,42 Seco y húmedo / Dry and wet	CLASE 1	R9	A
LENA Abujardado / Bush-hammered	> 0,6 Seco y húmedo / Dry and wet	> 0,42 Seco y húmedo / Dry and wet	CLASE 2	R10	A+B
MASAI Abujardado / Bush-hammered	> 0,6 Seco y húmedo / Dry and wet	> 0,42 Seco y húmedo / Dry and wet	CLASE 2	R10	A+B
MASAI Non-Slip	> 0,6 Seco y húmedo / Dry and wet	> 0,42 Seco y húmedo / Dry and wet	CLASE 3	R12	A+B+C
METEORA Abujardado / Bush-hammered	> 0,6 Seco y húmedo / Dry and wet	> 0,42 Seco y húmedo / Dry and wet	CLASE 2	R10	A+B
METEORA Non-Slip	> 0,6 Seco y húmedo / Dry and wet	> 0,42 Seco y húmedo / Dry and wet	CLASE 3	R12	A+B+C

VALORES DE ANTIDESLIZAMIENTO PRODUCTO INALCO NON-SLIP VALUES INALCO PRODUCTS

COLECCIÓN COLLECTION	NORMA / NORM ASTM-C 1028-96: COF	NORMA / NORM ANSI A 137.1: 2012 DCOF	NORMA / NORM UNE-ENV 12633	NORMA / NORM DIN 51130	NORMA / NORM DIN 51097
MOON Abujardado / Bush-hammered	> 0,6 Seco y húmedo / Dry and wet	> 0,42 Seco y húmedo / Dry and wet	CLASE 2	R10	A+B
MOON Non-Slip	> 0,6 Seco y húmedo / Dry and wet	> 0,42 Seco y húmedo / Dry and wet	CLASE 3	R12	A+B+C
OXIDE Natural / Natural	> 0,6 Seco y húmedo / Dry and wet	> 0,42 Seco y húmedo / Dry and wet	CLASE 1	R9	A
PACIFIC Natural / Natural	> 0,6 Seco y húmedo / Dry and wet	> 0,42 Seco y húmedo / Dry and wet	CLASE 1	R9	A
PACIFIC Abujardado / Bush-hammered	> 0,6 Seco y húmedo / Dry and wet	> 0,42 Seco y húmedo / Dry and wet	CLASE 2	R10	A+B
PACIFIC Non-Slip	> 0,6 Seco y húmedo / Dry and wet	> 0,42 Seco y húmedo / Dry and wet	CLASE 3	R12	A+B+C
PETRA Natural / Natural	> 0,6 Seco y húmedo / Dry and wet	> 0,42 Seco y húmedo / Dry and wet	CLASE 2	R10	A+B
PETRA Non-Slip	> 0,6 Seco y húmedo / Dry and wet	> 0,42 Seco y húmedo / Dry and wet	CLASE 3	R12	A+B+C
RIFT Natural / Natural	> 0,6 Seco y húmedo / Dry and wet	> 0,42 Seco y húmedo / Dry and wet	CLASE 1	R9	A
SENDA Natural / Natural	> 0,6 Seco y húmedo / Dry and wet	> 0,42 Seco y húmedo / Dry and wet	CLASE 2	R10	A+B
SILK Natural / Natural	> 0,6 Seco y húmedo / Dry and wet	> 0,42 Seco y húmedo / Dry and wet	CLASE 1	R9	A
SILK Abujardado / Bush-hammered	> 0,6 Seco y húmedo / Dry and wet	> 0,42 Seco y húmedo / Dry and wet	CLASE 2	R10	A+B
SOHO Abujardado / Bush-hammered	> 0,6 Seco y húmedo / Dry and wet	> 0,42 Seco y húmedo / Dry and wet	CLASE 2	R10	A+B
SOHO Non-Slip	> 0,6 Seco y húmedo / Dry and wet	> 0,42 Seco y húmedo / Dry and wet	CLASE 3	R12	A+B+C
STORM Natural / Natural	> 0,6 Seco y húmedo / Dry and wet	> 0,42 Seco y húmedo / Dry and wet	CLASE 1	R9	A
SYROS Natural / Natural	> 0,6 Seco y húmedo / Dry and wet	> 0,42 Seco y húmedo / Dry and wet	CLASE 1	R9	A
TOUCHÉ Natural / Natural	> 0,6 Seco y húmedo / Dry and wet	> 0,42 Seco y húmedo / Dry and wet	CLASE 1	R9	A
TOUCHÉ Abujardado / Bush-hammered	> 0,6 Seco y húmedo / Dry and wet	> 0,42 Seco y húmedo / Dry and wet	CLASE 2	R10	A+B
UMBRA Natural / Natural	> 0,6 Seco y húmedo / Dry and wet	> 0,42 Seco y húmedo / Dry and wet	CLASE 1	R9	A
UMBRA Non-Slip	> 0,6 Seco y húmedo / Dry and wet	> 0,42 Seco y húmedo / Dry and wet	CLASE 3	R12	A+B+C
VINT Natural / Natural	> 0,6 Seco y húmedo / Dry and wet	> 0,42 Seco y húmedo / Dry and wet	CLASE 1	R9	A
VINT Abujardado / Bush-hammered	> 0,6 Seco y húmedo / Dry and wet	> 0,42 Seco y húmedo / Dry and wet	CLASE 2	R10	A+B



LIMPIEZA Y MANTENIMIENTO / CLEANING AND MAINTENANCE

RECOMENDACIONES DE USO

Para preservar la belleza del producto INALCO se recomienda seguir las siguientes indicaciones:

Al finalizar las operaciones de colocación, realizar una adecuada limpieza para eliminar residuos de junta y la suciedad general de la obra.

Antes de empezar a limpiar, esperar a que el cemento de las juntas esté totalmente fraguado. El fabricante del mismo especifica el tiempo requerido.

Impregnar la superficie con agua limpia repartiéndola con la fregona.

Se diluye en agua el producto de limpieza en proporción 1:5 ó 1:10 en función de la cantidad de suciedad. Extender la disolución abundantemente sobre la superficie con la fregona y dejar actuar durante diez minutos.

Aclarar varias veces con abundante cantidad de agua limpia para recoger los residuos producidos.

Si los restos de suciedad (cemento) están muy secos o hay mucha cantidad, repetir estos pasos las veces que sea necesario frotando con la ayuda de un cepillo de fibras de plástico para potenciar la acción del producto.

Para eliminar el polvo ambiental es adecuado pasar una mopa seca, no se recomienda la utilización de productos cerosos ni abrillantadores.

No realizar la limpieza de las superficies Inalco con estropajos metálicos o abrasivos.

Los acabados pulido brillo y los colores oscuros son más sensibles al rayado, por lo que se recomienda no arrastrar objetos metálicos sin protección.

RECOMMENDED USES

For the INALCO's products to conserve their original beauty, these guidelines should be followed:

When the tiles have been laid, the surface must be thoroughly cleaned to remove any surplus grouting material or dirt from the tile laying process.

Before proceeding to clean the surface, wait until the tile grout is fully set. The manufacturer will specify the required setting time.

Mop the surface with plenty of clean water.

Dilute 1 part of cleaning agent in 5 or 10 parts of water, depending on the amount of dirt. Spread the solution thoroughly over the floor and leave it to act for about 10 minutes.

Rinse the surface several times with lots of clean water so as to remove any waste material or dirt.

If the dirt (cement) remains are very dry or there are a lot of them, repeat the above procedure as many times as necessary, rubbing it with a plastic fibers brush to enhance the action of the product.

To remove environmental dust, use a dry dust mop. It is not advisable to use wax-based products or self-shining wax.

Do not clean Inalco surfaces with metal or abrasive scouring pads.

Surfaces with glossy polished finishes or dark colours are easier to scratch and so metal objects should not be dragged directly across their surfaces.

LIMPIEZA Y MANTENIMIENTO / CLEANING AND MAINTENANCE

LIMPIEZA

El producto INALCO tiene una superficie sin prácticamente porosidad, por lo que resulta muy fácil de limpiar. Aún así, ante diferentes manchas que se pueden producir con el uso cotidiano, es necesario seguir una serie de indicaciones.

Se recomienda limpiar las manchas inmediatamente con un paño humedecido en agua, evitando que se resequen.

En el caso de manchas reseca, dejar la zona de la mancha humedecida con agua caliente con el fin de reblandecer la suciedad para después retirarla con un paño limpio.

Antes de aplicar cualquier tipo de producto en los acabados pulido brillo, probar en una zona poco visible para comprobar que no sufre alteraciones de brillo ni color.

CLEANING

Inalco product has an almost non-porous surface and so it is easy to clean. Even so, a series of guidelines should be followed to remove different everyday stains.

The stains should be cleaned away as soon as they occur, using a cloth moistened with water, to prevent them from drying.

In the case of dry stains, moisten the area with hot water in order to soften the dirt and then remove it with a clean cloth.

Before any type of cleaning product is used products with a glossy polished finish, test it out on an area that is not very visible to check that the shine or colour are not affected by the product.

LIMPIEZA SEGÚN EL TIPO DE MANCHA CLEANING INSTRUCTIONS BY TYPE OF STAIN	
TIPO DE MANCHA TYPE OF STAIN	DETERGENTE DETERGENT
Grasa / Fat or grease	Alcalino o Disolvente / Alkaline or Solvent
Aceite / Oil	Disolvente / Solvent
Tinta / Ink	Disolvente / Solvent
Café / Coffee	Alcalino o Ácido / Alkaline or Acidic
Vino / Wine	Alcalino o Ácido / Alkaline or Acidic
Zumo de frutas / Fruit juice	Oxidante / Oxidant
Refrescos / Soft drinks	Oxidante / Oxidant
Colorantes alimenticios / Food colouring	Oxidante / Oxidant
Caucho / Rubber	Disolvente / Solvent
Rotulador permanente / Indelible pen	Disolvente / Solvent
Restos cementosos / Cement residues	Ácido / Acidic
Nicotina / Nicotine	Disolvente u Oxidante / Solvent or Oxidant
Resina / Resin	Disolvente / Solvent
Yodo / Iodine	Oxidante / Oxidant
Sangre / Blood	Oxidante / Oxidant
Cera de vela / Candle wax	Disolvente / Solvent

Detergente Ácido: desincrustante, quitacemento, decapantes, etc. / Acidic detergent: acidic cleaning products like lime scale, cement or paint remover.
Detergente Alcalino: Productos de limpieza de carácter básico: desengrasante, amoníaco, etc. / Alkaline detergent: alkaline cleaning products like grease remover or ammonia.
Disolvente: Aguarrás, acetona, alcohol, disolvente universal, etc. / Solvent: turpentine, acetone, universal solvent etc.
Detergente Oxidante: Lejía diluida, agua oxigenada, etc. / Oxidant detergent: diluted bleach, peroxide etc.

Para más información, consulte ÁREA TÉCNICA en <https://www.inalco.es> / For further information, check TECH AREA at <https://www.inalco.es>.



CARACTERÍSTICAS TÉCNICAS MDI PARA PAVIMENTOS Y REVESTIMIENTOS MDI TECHNICAL CHARACTERISTICS FOR FLOOR AND WALL SURFACES

	Características técnicas según normas: Technical characteristics: Caractéristiques techniques selon les normes : Vorschriftsmäßige technische Eigenschaften: Caratteristiche tecniche secondo le norme: Технические характеристики согласно стандартам:	Norma de referencia Reference standard Norme de référence Referenznorm Standard di riferimento Стандарт	Valor requerido Value required Valeur exigée Erforderlicher Wert Valore richiesto Требуемое значение	Valor medio obtenido Mean value Valeur moyenne obtenue Erzielter Durchschnittswert Risultato ottenuto Среднее полученное значение
Características dimensionales / Desviación admisible respecto de la dimensión de fabricación	Longitud y anchura Length and width Longueur et largeur Länge und Breite Lunghezza e larghezza Длина и ширина	EN-ISO 10545-2	± 0,6 % / ± 2,0 mm	± 0,6 % / ± 2,0 mm
	Grosor Thickness Épaisseur Dicke Spessore Толщина	EN-ISO 10545-2	± 5 % / ± 0,5 mm	± 5 % / ± 0,5 mm
	Rectitud de los lados Warpages of edges Rectitude des côtés Kantengeradheit Rettilineità dei lati Выровненность бортов	EN-ISO 10545-2	± 0,5 % / ± 1,5 mm	± 0,5 % / ± 1,5 mm
	Ortogonalidad Wedging Orthogonalité Rechtwinkligkeit Ortogonalità Прямоугольность	EN-ISO 10545-2	± 0,6 % / ± 2,0 mm	± 0,6 % / ± 2,0 mm
	Planaridad Flatness Planéité Ebenflächigkeit Planarità Плоскостность	EN-ISO 10545-2	± 0,5 % / ± 2,0 mm	± 0,5 % / ± 2,0 mm
	Aspecto superficial Surface appearance Aspect de la surface Das Oberflächenaussehen Aspetto superficiale Внешний вид поверхности	EN-ISO 10545-2	Min. 95% piezas libres de defectos Min. 95% of pieces without defects Min. 95% des pièces sans défauts visibles Mind. 95% der Fliesen haben keinen Defekt Min. 95% pezzi senza difetto Мин. 95% бездефектных плиток	Min. 95% piezas libres de defectos Min. 95% of pieces without defects Min. 95% des pièces sans défauts visibles Mind. 95% der Fliesen haben keinen Defekt Min. 95% pezzi senza difetto Мин. 95% бездефектных плиток
Características químicas	Resistencia a productos domésticos de limpieza y aditivos de piscina Resistance to household cleaning products and swimming pool additives Résistance aux produits ménagers de nettoyage et aux additifs pour piscines Beständigkeit gegen Haushaltsreiniger und Schwimmbadzusätze Resistenza ai prodotti pulenti domestici e agli aditivi per l'acqua delle piscine Устойчивость к воздействию бытовых чистящих средств и добавок для бассейна	EN-ISO 10545-13	Min. GB GB min. Min. GB Min. GB Min. GB мин. GB	Resiste (A) Resist (A) Résiste (A) Beständig (A) Resiste (A) Да (A)
	Resistencia a ácidos y bases en baja concentración Resistance to acids and bases in low concentration Résistance aux acides et bases à faibles concentrations Beständigkeit gegen Säuren und Laugen in geringer Konzentration Resistenza agli acidi e alcali a bassa concentrazione Устойчивость к воздействию кислот и щелочей низкой концентрации	EN-ISO 10545-13	Indicada por el fabricante As indicated by manufacturer Indiquée par le fabricant Herstellerangaben Indicata dal fabbricante Указанное производителем	Resiste (LA) Resist (LA) Résiste (LA) Beständig (LA) Resiste (LA) Да (LA)
	Resistencia a las manchas Resistance to staining Résistance aux taches Fleckenbeständigkeit Resistenza alle macchie Спротивление пятнообразованию	EN-ISO 10545-14	Min. Clase 3 Class 3 min. Min. Classe 3 Min. Klasse 3 Min. classe 3 мин. Класс 3	Clase 5 Class 5 Classe 5 Klasse 5 Classe 5 Класс 5

CARACTERÍSTICAS TÉCNICAS MDI PARA PAVIMENTOS Y REVESTIMIENTOS MDI TECHNICAL CHARACTERISTICS FOR FLOOR AND WALL SURFACES

	Características técnicas según normas: Technical characteristics: Caractéristiques techniques selon les normes : Vorschriftsmäßige technische Eigenschaften: Caratteristiche tecniche secondo le norme: Технические характеристики согласно стандартам:	Norma de referencia Reference standard Norme de référence Referenznorm Standard di riferimento Стандарт	Valor requerido Value required Valeur exigée Erforderlicher Wert Valore richiesto Требуемое значение	Valor medio obtenido Mean value Valeur moyenne obtenue Erzielter Durchschnittswert Risultato ottenuto Среднее полученное значение	
Características físicas	Absorción de agua Water adsorption Absorption d'eau Wasseraufnahme Assorbimento d'acqua Влагопоглощение	EN-ISO 10545-3	≤ 0,5 %	≤ 0,2 %	
	Fuerza de rotura Breaking strength Force de rupture Bruchkraft Carico di rotura Сила разрыва	EN-ISO 10545-4	≥ 700 N	Supera la norma Standard overtakes Dépasse la norme Über die norm Supera lo standard Превышает норму	
		Standard Thickness	EN-ISO 10545-4	≥ 1.300 N	
	Resistencia a la flexión Bending strength Résistance à la flexion Biegefestigkeit Resistenza alla flessione Спротивление изгибу	EN-ISO 10545-4	≥ 35 N / mm ²	Supera la norma Standard overtakes Dépasse la norme Über die norm Supera lo standard Превышает норму	
	Resistencia a la abrasión profunda Resistance to deep abrasion Résistance à l'abrasion profonde Widerstandsfähigkeit gegen Tiefenabrieb Resistenza all'abrasione profonda Спротивление глубокому истиранию	EN-ISO 10545-6	≤ 175 mm ³	≤ 135 mm ³	
	Dilatación térmica lineal Lineal thermal expansion Dilatation thermique linéaire Lineare Wärmedehnung Dilatazione termica lineare Линейное тепловое расширение	EN-ISO 10545-8	Método disponible Method available Méthode disponible Verfügbares Verfahren Metodo disponibile Имеющаяся методика	≤ 9 x 10 ⁻⁶ K ⁻¹	
	Resistencia al choque térmico Thermal shock resistance Résistance au choc thermique Beständigkeit gegen Temperaturschwankungen Resistenza all'abrasione Устойчивость к резким перепадам температуры	EN-ISO 10545-9	Método disponible Method available Méthode disponible Verfügbares Verfahren Metodo disponibile Имеющаяся методика	Resiste Resist Résiste Beständig Resiste Да	
	Resistencia a la helada Frost resistance Résistance au gel Frostbeständigkeit Resistenza al gelo Морозоустойчивость	EN-ISO 10545-12	Exigida Required Requis Erfordert Obbligatorio Требуемая	Resiste Resist Résiste Beständig Resiste Да	
	Comportamiento frente al fuego de productos de construcción y edificación Resistance to fire of products for construction and building Comportement des produits de construction et édification face au feu Brandverhalten der Baustoffe Reazione al fuoco di prodotti di costruzione e edificazione Поведение перед огнём строительных изделий	EN 13051	Indicada por el fabricante As indicated by manufacturer Indiquée par le fabricant Herstellerangaben Indicata dal fabbricante Указано производителем	A1 - A1 _{FL}	
	Índice de propagación de la llama Flame spread rating Taux de propagation de la flamme Feuerwiderstandsklasse Indici di propagazione della fiamma Индекс распространения пламени	ASTM E-84	Indicada por el fabricante As indicated by manufacturer Indiquée par le fabricant Herstellerangaben Indicata dal fabbricante Указано производителем	Clase I - A Class I - A Classe I - A Klasse I - A Clase I - A Класс I - A	



CONSEJOS DE COLOCACIÓN / LAYING TIPS

ES

1. Nuestra documentación técnica no puede reflejar todas las aplicaciones y factores que intervienen en la obra en el uso y colocación de un material. Por este motivo, antes de emplear nuestros productos, el responsable del proyecto, arquitecto o prescriptor, debe establecer que tanto éste como el resto de productos que se utilizan para su colocación son los adecuados para el uso previsto. En cualquier caso, asume toda la responsabilidad que pueda resultar de su empleo.
2. Antes de colocar el material se debe comprobar la tonalidad, calibre y calidad.
3. Mezclar piezas de varias cajas MDi al colocar.
4. El soporte debe estar libre de polvo, grasas y humedad. Se deben eliminar los restos de otros materiales, como residuos de cemento, cal,... También debe ser estable, estar libre de fisuras y se debe haber comprobado su planaridad.
5. Se utilizará un material de agarre adecuado tanto para el producto MDi como para el soporte destinado. Siempre se deben seguir las instrucciones del fabricante del material de agarre que se va a aplicar.
6. Se utilizará la técnica del doble encolado, colocando cemento cola tanto en la pieza como en el suelo. De esta forma, garantizaremos que el 100 % de la superficie está cubierta por material de agarre y que no existen huecos que puedan provocar roturas. No olvidar repasar el adhesivo sobre los ángulos y bordes de la pieza.
7. No aplicar el cemento cola con riesgo de helada o en periodos de máximo calor. Tampoco aplicar el cemento en días lluviosos.
8. Para colocar MDi, ya sea en pared o en suelo, se deben guardar unas juntas mínimas entre las piezas. Estas juntas deberán tener una separación mínima de 2 mm. El espacio resultante se deberá rellenar con material adecuado para tal fin con un color similar al de la superficie. Siempre se deben seguir las instrucciones del fabricante del material de rejuntado que se va a utilizar.
9. Es necesaria la utilización de un set de autoniveladores a la hora de colocar el material con el fin de evitar desniveles y cejas entre las piezas.
10. Nunca utilizar un mazo de goma para aplanar las piezas; utilizar en este caso una llana de goma.
11. Se recomienda no trabar las piezas MDi.
12. Para la colocación del pavimento en exteriores, el material de solado y juntas debe tener propiedades específicas para tal ubicación.
13. Debe evitarse limpiar la superficie con detergentes y productos corrosivos. En caso de ser necesario existen productos específicos para cada tipo de suciedad. Consultar siempre las instrucciones de dichos productos.
14. El colocador debe ser cauto a la hora de manipular y colocar piezas rectificadas para no dañar los cantos de las piezas.
15. Una vez finalizada la colocación, se deben eliminar enseguida los restos de materiales de agarre y rejuntado respetando el tiempo de espera indicado por los fabricantes de estos productos. En el caso de que se hayan secado, actuar sobre las piezas con un desincrustante ácido comercial destinado a tal fin, atendiendo a sus instrucciones de uso. Utilizar una esponja limpia, no usar estropajos u otros materiales que puedan rayar la superficie.
16. El no cumplimiento de estas recomendaciones exime a Inalco de toda responsabilidad, por uso impropio o imperfecta colocación. No se admitirán reclamaciones del material MDi ya colocado.

CONSEJOS DE COLOCACIÓN / LAYING TIPS

EN

1. Our technical literature cannot reflect all possible applications or factors involved in the on-site use and installation of our products. As a result, before they are used, the project manager, architect or materials specifier should make sure that these materials and any others used to lay them are suitable for the intended use, being fully responsible for the outcome of their use.
2. Before proceeding to lay the pieces, check their shade, calibre and choice.
3. Use a mixture of MDi pieces from different boxes when laying them.
4. The substrate must be free from dust, oil, grease, and the remains of other building materials (cement, lime etc). It should not be damp, and it must be stable, with no cracks. Checks should be made to ensure that it is level.
5. Appropriate adhesive must be used for the type of MDi and substrate in question. Always follow the manufacturer's instructions for the adhesive to be used.
6. Use the floating and buttering method, spreading cement-based adhesive on both the substrate and the underside of the pieces. In this way, the whole surface will be covered with the adhesive, avoiding possible voids that might lead to broken pieces. Do not forget to check that the edges and corners of the pieces are covered in adhesive.
7. Do not apply cement-based adhesive when there is a risk of frost or ice, during very hot periods, or on rainy days.
8. To lay the MDi on walls or floors, make sure that a minimum joint of 2 mm is left between the pieces. The resulting joint should be filled with suitable grouting of a colour similar to the surface. Always follow the manufacturer's instructions for the grouting material to be used.
9. Use a set of levellers when laying the pieces to avoid uneven or bulging pieces.
10. Never use a rubber mallet to tap the product into place. Use a rubber trowel.
11. MDi should not be laid staggered.
12. When laying floors outdoors, the adhesive and grouting should have the right properties for the place where they will be laid.
13. Do not clean the product with detergents or corrosive products. If necessary, there are specific products for removing different types of dirt. Always follow the instructions of the product in question.
14. When handling and laying rectified pieces, layers should take care not to damage the corners.
15. Once the pieces have been laid, remove any surplus bonding or grouting material as soon as the waiting time indicated by their manufacturers has elapsed. If this residue has dried, use a commercial acidic cement remover designed for this purpose, following the instructions of use. Use a clean sponge. Do not use a scouring pad or other materials that might scratch the surface.
16. Inalco cannot be held liable if these recommendations are not followed or if the tiles are wrongly laid. No claims will be accepted for MDi once it has been laid.



CONSEJOS DE COLOCACIÓN / LAYING TIPS

FR

1. Notre documentation technique ne peut pas refléter la totalité des applications et des facteurs qui interviennent au chantier dans le cadre de l'utilisation et de la pose d'un matériau. C'est la raison pour laquelle il est nécessaire, avant d'employer nos produits, que le responsable du projet, l'architecte ou le prescripteur s'assurent que ceux-ci et les autres produits à utiliser en vue de leur pose sont appropriés à l'usage prévu. Ils assument dans tous les cas l'entière responsabilité des éventuelles conséquences de l'emploi de ces produits.
2. Avant de poser le matériau, il convient de contrôler la couleur, le calibre et la qualité de ce dernier.
3. Pour la pose, mélanger des pièces MDi provenant de différents cartons.
4. Il ne peut pas y avoir de poussière, de graisses ou d'humidité sur le support. Il est nécessaire d'éliminer les restes d'autres matériaux, tels que ceux de ciment, de chaux, etc. Le support doit de même être stable et sans fissures, et sa planéité doit être parfaite.
5. Employer un matériau de pose adéquat aussi bien pour le produit MDi que pour le support appelé à recevoir celui-ci. Respecter dans tous les cas les conseils du fabricant du matériau de pose à appliquer.
6. Procéder par la technique du double encollage en enduisant de mortier colle aussi bien la pièce que le sol. Cette méthode permet de garantir que la surface est couverte à 100 % de matériau de pose et qu'il n'existe pas de creux susceptibles de provoquer des ruptures. Ne pas oublier de bien repasser la colle sur les angles et les bords des pièces.
7. Ne pas appliquer le mortier colle s'il y a risque de gel ou lors des périodes de chaleur extrême. Ne pas appliquer non plus le mortier colle les jours de pluie.
8. La pose des pièces, que ce soit sur un mur ou sur un sol, doit impérativement être réalisée en prévoyant des joints minimums entre les pièces. L'écart entre les pièces doit être au moins de 2 mm. Le creux résultant doit être rempli d'un matériau de jointoiment conçu à cet effet et d'une couleur similaire à celle des pièces. Respecter dans tous les cas les conseils du fabricant du matériau de jointoiment à employer.
9. En posant le matériau, il est nécessaire d'employer des pièces de nivellement afin d'éviter les dénivelés et les différences de niveau entre les pièces.
10. N'employer sous aucun prétexte un maillet en caoutchouc pour frapper les pièces et les mettre à niveau. Utiliser pour ce faire une taloche en caoutchouc.
11. La pose décalée est déconseillée.
12. Pour poser des pièces de sol dans les espaces extérieurs, les matériaux de pose et de jointoiment doivent posséder des propriétés spécifiques à ce type de lieux.
13. Éviter de nettoyer la surface avec des détergents ou des produits corrosifs. En cas de besoin, il existe des produits spécifiques pour chaque type de salissures. Lire impérativement les conseils qui accompagnent ces produits.
14. En manipulant et en posant des pièces rectifiées, le carreleur doit être vigilant et veiller à ne pas endommager les bords des pièces.
15. Au terme de la pose, il est nécessaire d'éliminer les restes de matériaux de pose et de jointoiment immédiatement après le temps d'attente préconisé par les fabricants de ces produits. Si ces matériaux ont séché, employer un produit désincrustant acide du commerce prévu à cet effet, en respectant toujours le mode d'emploi de celui-ci. Utiliser une éponge propre et éviter d'employer des éponges abrasives ou d'autres matériaux susceptibles de rayer la surface.
16. Le non respect de ces recommandations exempte Inalco de toute responsabilité en cas d'utilisation indue ou de pose incorrecte. La société n'admettra aucune réclamation concernant le matériau MDi déjà posé.

CONSEJOS DE COLOCACIÓN / LAYING TIPS

DE

1. In unseren technischen Datenblättern können nicht alle Anwendungen und Faktoren genannt werden, die bei den Bauarbeiten zur Benutzung und Verlegung von Materialien auftreten. Aus diesem Grunde muss der Projektleiter, Architekt oder der Materialberater festlegen, dass sowohl dieses als auch alle anderen Produkte, die zur Verlegung benutzt werden, für die geplante Verwendung geeignet sind. Er übernimmt auf jeden Fall die gesamte Verantwortung, die sich aus der Anwendung ergeben könnte.
2. Vor dem Verlegen des Materials müssen Farbton, Kaliber und Qualität geprüft werden.
3. Beim Verlegen sollten die Teile aus verschiedenen MDi-Kartons vermischt werden.
4. Der Untergrund muss frei von Staub, Fett und Feuchtigkeit sein. Dazu müssen alle anderen Materialreste wie Zement, Kalk usw. entfernt werden. Er muss zudem stabil sein, darf keine Risse aufweisen und die Ebenflächigkeit muss geprüft worden sein.
5. Der verwendete Kleber muss sowohl für das MDi-Produkt als auch für den entsprechenden Untergrund geeignet sein. Für den zu benutzenden Kleber müssen immer die Herstelleranweisungen befolgt werden.
6. Das Material wird mit dem Battering-Floating-Verfahren verlegt, d. h., der Kleber wird sowohl auf das Teil als auch auf den Boden aufgetragen. Dadurch wird sichergestellt, dass die gesamte Fläche mit Kleber bedeckt ist und keine Löcher vorhanden sind, die Brüche in den Teilen verursachen könnten. Achten Sie darauf, dass auch die Ecken des Teils gut mit Kleber bestrichen sind.
7. Der Zementkleber darf nicht bei Frostgefahr oder großer Hitze verwendet werden. Auch an Regentagen ist es nicht ratsam, Zementkleber zu benutzen.
8. Zum Verlegen von MDi, ganz gleich ob an der Wand oder auf dem Boden, müssen zwischen den Teilen Fugenabstände mit einer gewissen Mindestbreite eingehalten werden. Diese Fugen müssen mindestens 2 mm breit sein. Die jeweilige leere Fuge zwischen den Teilen muss mit hierzu geeignetem Material in einer ähnlichen Farbe ausgefüllt werden. Für das zu verwendende Fugenmaterial sind immer die Herstelleranweisungen zu befolgen.
9. Zum Verlegen des Materials ist ein Nivelliersystem erforderlich, um Höhenunterschiede und ein Überstehen der Teile zu vermeiden.
10. Damit die Teile flach zu liegen kommen, darf nie ein Gummihammer verwendet werden. Stattdessen ist ein Gummispachtel besser geeignet.
11. Die MDi-Teile sollten nicht versetzt verlegt werden.
12. Zum Verlegen von Bodenbelägen in Außenbereichen müssen Untergrund und Fugenmaterial die geeigneten Eigenschaften für diese Bereiche besitzen
13. Die Oberfläche darf nicht mit korrosiven Putzmitteln und Produkten gereinigt werden. Gegebenenfalls sind Spezialprodukte für jede Art von Schmutz erhältlich. Für diese Produkte sind immer die entsprechenden Anweisungen zu befolgen.
14. Die Verlegungsfachkraft muss beim Handhaben und Verlegen von rektifizierten Teilen Vorsicht walten lassen, damit die Kanten nicht beschädigt werden.
15. Nach Abschluss der Verlegung müssen unverzüglich die Kleber- und Fugenmaterialreste entfernt werden, wobei die von den jeweiligen Herstellern angegebenen Wartezeiten einzuhalten sind. Falls diese Reste bereits angetrocknet sind, sollten die Teile mit einem hierzu bestimmten, handelsüblichen und säurehaltigen Zemententferner unter Befolgung der Gebrauchsanweisungen bearbeitet werden. Dazu sollte ein sauberer Schwamm verwendet werden, keinesfalls Scheuerschwämme oder andere Produkte, mit denen die Oberfläche verkratzt werden könnte.
16. Eine Nichterfüllung dieser Empfehlungen enthebt Inalco wegen unangemessener Benutzung oder fehlerhafter Verlegung von jeder Haftung. Für bereits verlegtes MDi-Material sind keine Beanstandungen mehr zulässig.



CONSEJOS DE COLOCACIÓN / LAYING TIPS

IT

1. Nella nostra documentazione tecnica non è possibile riportare tutte le applicazioni e i fattori che intervengono nell'uso e nella posa in opera di un materiale. Per questa ragione, prima di utilizzare i nostri prodotti, il responsabile del progetto - architetto o committente - deve accertarsi che sia questo che gli altri prodotti impiegati per la posa in opera siano adatti all'uso previsto. In ogni caso, si assume tutta la responsabilità derivante dal loro uso.
2. Prima di posare il materiale, occorre verificarne la tonalità, il calibro e la qualità.
3. Prima della posa, mescolare i pezzi MDi di varie scatole.
4. Il supporto deve essere privo di polvere, grasso e umidità. Devono essere rimosse le tracce di altri materiali, quali macchie di cemento, calcare, ecc. Deve anche essere stabile, essere esente da crepe e occorre verificarne la planarità.
5. Usare un adesivo adatto sia per il prodotto MDi che per il supporto. Seguire sempre le istruzioni del produttore dell'adesivo che si desidera impiegare.
6. Usare la tecnica della doppia spalmatura, cioè applicare l'adesivo sia sul pezzo che sul pavimento. In tal modo, si garantisce che il 100% della superficie sia coperta dall'adesivo e che non si vengano a creare vuoti in grado di provocare rotture. Non dimenticare di ripassare l'adesivo sugli angoli e i bordi del pezzo.
7. Non applica l'adesivo in caso di rischio di gelata, nei periodi di massimo calore, né nei giorni di pioggia.
8. Per la posa di MDi, sulle pareti o sui pavimenti, rispettare le fughe minime tra i pezzi. Queste fughe devono avere una separazione minima di 2 mm. Lo spazio risultante deve essere riempito con un apposito materiale adatto con un colore simile a quello della superficie. Seguire sempre le istruzioni del produttore del prodotto per la stuccatura delle fughe che si desidera impiegare.
9. Per la posa del materiale è necessario usare un set di distanziatori livellanti per evitare dislivelli e l'accumulo di adesivo tra i pezzi.
10. Per battere i pezzi, non usare mai un mazzuolo di gomma, ma esclusivamente una spatola di gomma.
11. Si consiglia di non sfalsare i pezzi MDi.
12. Per la posa in opera del pavimento da esterni, l'adesivo e lo stucco per le fughe devono avere proprietà specifiche per tale destinazione.
13. Evitare di pulire la superficie con detersivi e prodotti corrosivi. Se necessario, esistono prodotti specifici per ogni tipo di sporco. Seguire sempre le istruzioni del prodotto.
14. Il posatore deve procedere con cautela per la movimentazione e la posa dei pezzi rettificati per evitare di danneggiarne i bordi.
15. Una volta conclusa la posa in opera, rimuovere subito le tracce di adesivo e della stuccatura delle fughe, rispettando il tempo di attesa indicato dai rispettivi produttori. In caso di essiccazione, pulire i pezzi con un apposito pulitore a base acida reperibile in commercio, attenendosi alle relative istruzioni per l'uso. Usare una spugna pulita e non pagliette metalliche o altri materiali in grado di graffiare la superficie del prodotto.
16. Inalco declina ogni responsabilità per eventuali reclami in caso di mancato rispetto di queste istruzioni, uso improprio o posa in opera eseguita male. Non si accettano reclami per il materiale MDi già posato.

CONSEJOS DE COLOCACIÓN / LAYING TIPS

RU

1. Наша техническая документация не может отражать все виды применения и факторы, имеющие место при использовании и укладке какого-либо материала на строительном объекте. Поэтому перед тем, как пользоваться нашей продукцией, ответственный за проект, архитектор или составитель спецификации, принимающий решение о выборе материала, должны обеспечить, чтобы и эта продукция, и средства для ее укладки подходили для предусмотренного применения. В любом случае вышеупомянутое лицо принимает на себя всю ответственность, которая может вытекать из вышеуказанного использования.
2. Перед укладкой материала следует проверить его тон, размер и качество.
3. При укладке смешивайте материал MDi из разных коробок.
4. Поверхность, на которую укладывается материал, должна быть свободной от пыли, жира и влаги. С нее следует удалить остатки других материалов, например, цемента, извести и т. п. Кроме того, она должна быть устойчивой, не иметь трещин, и нужно проверить, является ли она ровной плоскостью.
5. Следует использовать клеевой состав, который подходит как для данного продукта MDi, так и для поверхности, на которую он укладывается. При этом всегда следуйте инструкциям изготовителя клеевого состава, который будет применяться.
6. Воспользуйтесь техникой двойного приклеивания, нанося цементно-клеевой состав как на укладываемый материал, так и на поверхность пола. Таким образом вы сможете гарантировать, что 100% поверхности будет покрыто клеевым составом и что не существует отверстий, которые могут вызвать разломы. Не забудьте удостовериться в том, что клеящее вещество нанесено во всех углах и по краям каждого элемента покрытия.
7. Не следует применять цементно-клеевой состав тогда, когда существует риск заморозков, или, наоборот, в периоды сильной жары, а также в дождливые дни.
8. При укладке материала MDi, будь то для облицовки стен или напольных покрытий, надо оставлять минимальные швы толщиной не менее 2 мм между отдельными элементами. Образующиеся пространства следует заполнить подходящим для этого материалом, сходным по цвету с поверхностью. При этом всегда следуйте инструкциям изготовителя материала для заполнения швов, который будет применяться.
9. При укладке необходимо использовать набор самонивелиров, чтобы избежать сдвигов по высоте между разными укладываемыми элементами, а также их чрезмерного выступания.
10. Никогда не используйте для выравнивания элементов резиновый молоток: возьмите вместо этого резиновый шпатель.
11. Не рекомендуется укладывать элементы MDi «вразбежку».
12. При укладке напольных покрытий на открытом воздухе основной продукт и материал для заполнения швов должны обладать подходящими для этого специфическими характеристиками.
13. Избегайте чистить поверхность коррозионными моющими и другими средствами. На случай необходимости существуют специфические средства для каждого типа загрязнений. При этом надо всегда смотреть инструкции по применению этих средств.
14. При перемещении и укладке ректифицированных элементов укладчик должен проявлять осторожность, чтобы не повредить их края.
15. После завершения укладки следует сразу же удалить остатки клеевого состава и материала для заполнения швов, соблюдая при этом время ожидания, указанное их производителем. В том случае, если эти материалы засохли в ненадлежащем месте, надо воспользоваться имеющимся в продаже кислотным средством, специально предназначенным для их удаления, следуя соответствующим инструкциям по его применению. Пользуйтесь чистой мочалкой, не применяйте металлические мочалки или другие материалы, которые могли бы поцарапать поверхность.
16. Несоблюдение данных рекомендаций, включающее ненадлежащее использование или неправильную укладку, освобождает компанию Inalco от любой ответственности. Рекламации по уже уложенному материалу MDi не принимаются.

La reproducción de los colores es aproximada. INALCO se reserva el derecho de alterar o modificar los productos aquí relacionados.

The reproduction of the colours is approximate. INALCO reserves the right to alter or amend the products here stated.

La reproduction des couleurs est approximative. INALCO se réserve le droit d'altérer ou de modifier ses produits.

Die Wiedergabe der Farben ist nur eine Annäherung. INALCO behält sich das Recht vor, die hier angegebenen Produkte zu ändern oder auszutauschen.

La riproduzione del colore è approssimato. INALCO si riserva il diritto di alterare o modificare i relativi prodotti.

Цвета воспроизводятся приблизительно. INALCO оставляет за собой право модифицировать представленную здесь продукцию.



INDUSTRIAS ALCORENSES CONFEDERADAS S.A.

C/ San Salvador, 54
12110, Alcora (Castellón - España)

Tel.: (+34) 964 368 000
e-mail: correo@inalco.es

www.inalco.es
www.inalcotrends.com

